



KERN & Sohn GmbH

Ziegelei 1
D-72336 Balingen
email: info@kern-sohn.com

Phone: +49-[0]7433- 9933-0
Fax: +49-[0]7433-9933-149
Internet: www.kern-sohn.com

Operating Instructions

Pallet scales

KERN UFB/UFN

Version 1.1
02/2010
GB



UFB/UFN-BA-e-1011



KERN UFB/UFN

Version 1.1 02/2010

Operating Instructions Pallet scales

Table of Contents

1	Technical Data	4
2	Appliance overview display device	6
2.1	Keyboard overview	7
2.1.1	Numeric input via navigation keys	8
2.2	Overview of displays.....	8
3	Basic Information (General)	9
3.1	Proper use	9
3.2	Improper Use.....	9
3.3	Warranty	9
3.4	Monitoring of Test Resources.....	9
4	Basic Safety Precautions	10
4.1	Pay attention to the instructions in the Operation Manual	10
4.2	Personnel training.....	10
5	Transportation & Storage	10
5.1	Testing upon acceptance	10
5.2	Packaging / return transport	10
6	Unpacking and implantation	10
6.1	Installation Site, Location of Use	10
6.2	Unpacking.....	11
6.3	Scope of delivery / serial accessories:	11
6.4	Placing.....	11
6.5	Mains connection.....	12
6.6	Storage battery operation (optional).....	12
6.7	Adjustment.....	13
6.8	Verification.....	15

7	Operation	17
7.1	Start-up.....	17
7.2	Switching Off	17
7.3	Zeroing	17
7.4	Simple weighing	17
7.5	Weighing with tare	18
7.6	Weighing with tolerance range	18
7.7	Manual totalizing.....	21
7.8	Automatic adding-up.....	23
7.9	Animal weighing	24
7.10	Lock keyboard	24
7.11	Display background illumination	24
7.12	Automatic switch-off function "AUTO OFF"	25
8	Menu	26
9	Service, maintenance, disposal	28
9.1	Cleaning	28
9.2	Service, maintenance	28
9.3	Disposal.....	28
9.4	Error messages	28
10	Data output RS 232C	29
10.1	Technical Data.....	29
10.2	Printer mode	30
10.3	Continuous data output	30
11	Instant help.....	31

1 Technical Data

KERN	UFB 600K200M	UFB 1.5T0.5M
Readability (d)	200 g	500 g
Weighing range (max)	600 kg	1500 kg
Minimum load (Min)	4 kg	10 kg
Verification value (e)	200 g	500 g
Verification class	III	III
Reproducibility	200 g	500 g
Linearity	± 200 g	± 500 g
Recommended adjustment weight, not added (class)	600 kg (M2)	1.5 t (M2)
Warm-up time	10 minutes.	
Stabilization time (typical)	2-3 sec.	
Weighing unit	kg	
Auto Off	Available options 5, 15 min.	
Ambient temperature	-10°C – 40°C	
Moist environment	0 %- 80 % (non-condensing)	
Electric Supply	Input voltage 220 V – 240 V, 50 Hz	
	Power pack secondary voltage 9V, 800mA	
Dimensions display unit (B x D x H) mm	250 x 160 x 58	
Dimensions platform (B x T x H) mm	1100 x 1460 x 90	
Weighing surface mm	1100 x 1300	
Interface (Standard)	RS 232	

KERN	UFN 600K200IPM	UFN 1.5T0.5IPM
Readability (d)	200 g	500 g
Weighing range (max)	600 kg	1500 kg
Minimum load (Min)	4 kg	10 kg
Verification value (e)	200 g	500 g
Verification class	III	III
Reproducibility	200 g	500 g
Linearity	± 200 g	± 500 g
Recommended adjustment weight, not added (class)	600 kg (M2)	1.5 t (M2)
Warm-up time	10 minutes	
Stabilization time (typical)	2-3 sec.	
Weighing unit	kg	
Auto Off	Available options 5, 15 Min.	
Ambient temperature	-10°C – 40°C	
Moist environment	0 %- 95 % (non-condensing)	
Electric Supply	Input voltage 220 V – 240 V, 50 Hz	
	Power pack secondary voltage 9V, 800mA	
Dimensions display unit (B x D x H) mm	266 x 165 x 96	
Dimensions platform (B x T x H) mm	840 x 1350 x 90	
Weighing surface mm	840 x 1190	
IP protection	IP 67 as per DIN 60529	
Interface (Option)	RS 232	

2 Appliance overview display device









UFB: Plastic version

UFN: Stainless steel version







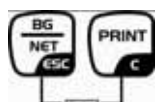
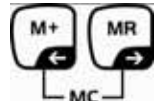

1. Battery status display
2. Keyboard
3. Weight display
4. Tolerance tag, see chpt 7.6
5. Weighing unit
6. RS-232
7. Input terminal load cell cable
8. Guide rail support base / stand
9. Stop support base / stand
10. Mains adapter connection
11. Adjustment switch

2.1 Keyboard overview

Button	Function
	⇒ Turn on/off
 Navigation key ←	<ul style="list-style-type: none"> • Zeroing • Confirm entry
 Navigation key ↑	<ul style="list-style-type: none"> • Taring • At numeric input increase flashing digit • Scroll forward in menu
 Navigation key →	<ul style="list-style-type: none"> • Display sum total • Digit selection to the right
 Navigation key ←	<ul style="list-style-type: none"> • Add weighing value in summation memory • Digit selection to the left
 C	<ul style="list-style-type: none"> • Calculate weighing data via interface • Delete
 ESC	<ul style="list-style-type: none"> • Switch-over gross weight ⇔ net weight • Back to menu/weighing mode
	⇒ Activate animal weighing function
	• Activate weighing with tolerance limits
 MC	• Delete total added memory

2.1.1 Numeric input via navigation keys

- ⇒ Press ; current setting appears. The first digit is flashing and can be changed.
- ⇒ If the first digit is not to be changed, press  and the second digit will start flashing. Each time you press , the display unit jumps to the subsequent digit, returning to the first digit after the last digit has been pressed.
- ⇒ To change the selected (flashing) digit, press  repeatedly until the desired value appears. Then select by  using *additional digits* and change these by using .
- ⇒ Finish entry with .

2.2 Overview of displays

Display	Significance
	Rechargeable battery very low
STABLE	Stability display
ZERO	Zero display
GROSS	Gross weight
NET	Net weight
AUTO	Automatic add-up enabled
Kg	Weighing unit
M+	Adding
LED + / ✓ / -	Indicators for weighing with tolerance limits

3 Basic Information (General)

3.1 Proper use

The display unit acquired by you is used in combination with a weighing plate and serves to determine the weighing value of material to be weighed. It is intended to be used as a “non-automatic weighing system”, i.e. the material to be weighed is manually and carefully placed in the centre of the weighing plate. As soon as a stable weighing value is reached the weighing value can be read.

3.2 Improper Use

Do not use display unit for dynamic weighings. In the event that small quantities are removed or added to the material to be weighed, incorrect weighing results can be displayed due to the “stability compensation“ in the display unit. (Example: Slowly draining fluids from a container on the balance.) Do not leave permanent load on the weighing plate. This may damage the measuring system.

Impacts and overloading exceeding the stated maximum load (max) of the weighing plate, minus a possibly existing tare load, must be strictly avoided. Both, the weighing plate and the display unit may be damaged during this process.

Never operate display unit in explosive environment. The serial version is not explosion protected.

Changes to the display unit's design are not permitted. This may lead to incorrect weighing results, safety-related faults and destruction of the display unit.

The display unit may only be operated in accordance with the described default settings. Other areas of use must be released by KERN in writing.

3.3 Warranty

Warranty claims shall be voided in case

- Our conditions in the operation manual are ignored
- The appliance is used outside the described uses
- The appliance is modified or opened
- Mechanical damage or damage by media, liquids, natural wear and tear
- The appliance is improperly set up or incorrectly electrically connected
- The measuring system is overloaded

3.4 Monitoring of Test Resources

In the framework of quality assurance the measuring-related properties of the display unit and, if applicable, the testing weight, must be checked regularly. The responsible user must define a suitable interval as well as type and scope of this test. Information is available on KERN's home page (www.kern-sohn.com) with regard to the monitoring of display units' test substances and the test weights required for this. In KERN's accredited DKD calibration laboratory test weights and display units may be calibrated (return to the national standard) fast and at moderate cost.

4 Basic Safety Precautions

4.1 Pay attention to the instructions in the Operation Manual

Carefully read this operation manual before setup and commissioning, even if you are already familiar with KERN balances.

4.2 Personnel training

The appliance may only be operated and maintained by trained personnel.

5 Transportation & Storage

5.1 Testing upon acceptance

When receiving the appliance, please check packaging immediately, and the appliance itself when unpacking for possible visible damage.

5.2 Packaging / return transport



- ⇒ Keep all parts of the original packaging for a possibly required return.
- ⇒ Only use original packaging for returning.
- ⇒ Prior to dispatch disconnect all cables and remove loose/mobile parts.
- ⇒ Reattach possibly supplied transport securing devices.
- ⇒ Secure all parts such as glass wind screen, weighing platform, power unit etc. against shifting and damage.

6 Unpacking and implantation

6.1 Installation Site, Location of Use

The display units are designed in a way that reliable weighing results are achieved in common conditions of use.

Precise and fast work is achieved by selecting the right place for your display unit and your weighing plate.

On the installation site observe the following:

- Place the display unit and the weighing plate on a stable, even surface.
- Avoid extreme heat as well as temperature fluctuation caused by installing next to a radiator or in the direct sunlight;
- Protect the display unit and the weighing plate against direct draft from open windows or doors.
- Avoid jarring during weighing;
- Protect the display unit and the weighing plate against high humidity, vapours and dust.

- Do not expose the display unit to extreme dampness for longer periods of time. Non-permitted condensation (condensation of air humidity on the appliance) may occur if a cold appliance is taken to a considerably warmer environment. In this case, acclimatize the disconnected appliance for ca. 2 hours at room temperature.
- Avoid static charge of goods to be weighed or weighing container.

Major display deviations (incorrect weighing results) may be experienced should electromagnetic fields (e.g. due to mobile phones or radio equipment), static electricity accumulations or instable power supply occur. Change location or remove source of interference.

IP 67 protection type as per DIN EN 60529 (KERN UFN only)

Suitable for short-term use in wet areas.

6.2 Unpacking

Carefully remove the display unit from packaging, remove plastic cover and place it in the designated work area.

6.3 Scope of delivery / serial accessories:

- Scale
- Mains power supply
- Operating instructions

6.4 Placing

Mount the display unit in a way that facilitates operation and where it is easy to see. Accurate weighing results require a weighing bridge with perfect horizontal alignment. During initial installation and after each change of work area it is necessary to level the weighing bridge.

Use with stand (optional)



An optional stand (KERN BFS-07) is available for raising the display unit.

6.5 Mains connection

Power is supplied via the external mains adapter. The stated voltage value must be the same as the local voltage. Only use original KERN mains adapters. Using other makes requires consent by KERN.

6.6 Storage battery operation (optional)

Before the first use, the battery should be charged by connecting it to the mains power supply for at least 12 hours.

The symbol appearing on the weight display  indicates that the battery is getting low. Approximately 10 h of instrument usage are left; afterwards it will shut off automatically. Use the supplied battery charger for charging the battery. Charge status of rechargeable battery is indicated by the LED display.

red: Voltage has dropped below prescribed minimum.

green: Rechargeable battery is completely charged

yellow: Charging storage battery

To save battery life, you can enable the automatic switch-off function "AUTO OFF", see chpt 7.12.

6.7 Adjustment

As the acceleration value due to gravity is not the same at every location on earth, each display unit with connected weighing plate must be coordinated - in compliance with the underlying physical weighing principle - to the existing acceleration due to gravity at its place of location (only if the weighing system has not already been adjusted to the location in the factory). This adjustment process must be carried out for the first commissioning, after each change of location as well as in case of fluctuating environment temperature. To receive accurate measuring values it is also recommended to adjust the display unit periodically in weighing operation.



- Access to menu block "P2 CAL" is locked in verified weighing systems.

KERN UFB

Access to menu requires breaking of seal and activation of adjustment switch (See chpt 6.8).

KERN UFN























In order to access the menu you will have to short-circuit the two contacts of the circuit board with a jumper (See chpt 6.8).

Attention:

The instrument will have to be reverified by a bureau of standards and a new seal attached if a seal was broken before applications subject to verification can be recommenced.

Please follow verification instructions (See chpt 6.8.).

- The applied adjustment weight depends on the weighing system's capacity. Carry out adjustment as near as possible to the maximum weight of the weighing system. Info about test weights can be found on the Internet at: <http://www.kern-sohn.com>
- Observe stable environmental conditions. Warm-up time required for stabilization.

- ⇒ Switch on instrument and press  during self-test. 
- ⇒ Press , ,  in turn and the first menu block “POCHK” will appear. 
- ⇒ Press  repeatedly until “P2 CAL” appears. 
- ⇒ Press  and the first menu item “COUNT” will appear.
At verified scales (KERN UFB), press first the adjustment switch. 
- ⇒ Press  repeatedly until “CAL” appears. 
- ⇒ Press . 
- ⇒ Wait for stability display, then press . Ensure that there are no objects on the weighing plate. 
- ⇒ The currently set adjustment weight will be displayed. 
- ⇒ Change by pressing the navigation keys (See chpt 2.1.1); select desired setting; currently enabled digit will be flashing.
- ⇒ Acknowledge by . 
- ⇒ Carefully place adjusting weight in the centre of the weighing plate. Wait for stability display, then press . 
- ⇒ After successful adjustment the appliance automatically returns to weighing mode. 



- An adjusting error or incorrect adjusting weight will be indicated by the error message, repeat adjustment procedure.
- KERN UFN
Prior to the next adjustment you will have to relock the access to menu block “P2 CAL” by disabling the jumper.

6.8 Verification

General introduction:

According to EU directive 90/384/EEC balances must be verified if they are used as follows (legally controlled area):

- a) For commercial transactions if the price of goods is determined by weighing.
- b) For the production of medicines in pharmacies as well as for analyses in the medical and pharmaceutical laboratory.
- c) For official purposes.
- d) For manufacturing final packages.

In cases of doubt, please contact your local trade in standard.

Verification notes:

An EU Qualification Approval is in existence for verified weighing systems. If a balance is used where obligation to verify exists as described above, it must be verified and re-verified in regular intervals.

Reverification is carried out according to relevant national statutory regulations. The validity for verification of balances in Germany is e.g. 2 years.

The legal regulation of the country where the balance is used must be observed!



- Verification of the weighing system is invalid without the "seal".

Notes on verified weighing systems

UFB:

Position for seals and adjustment switches

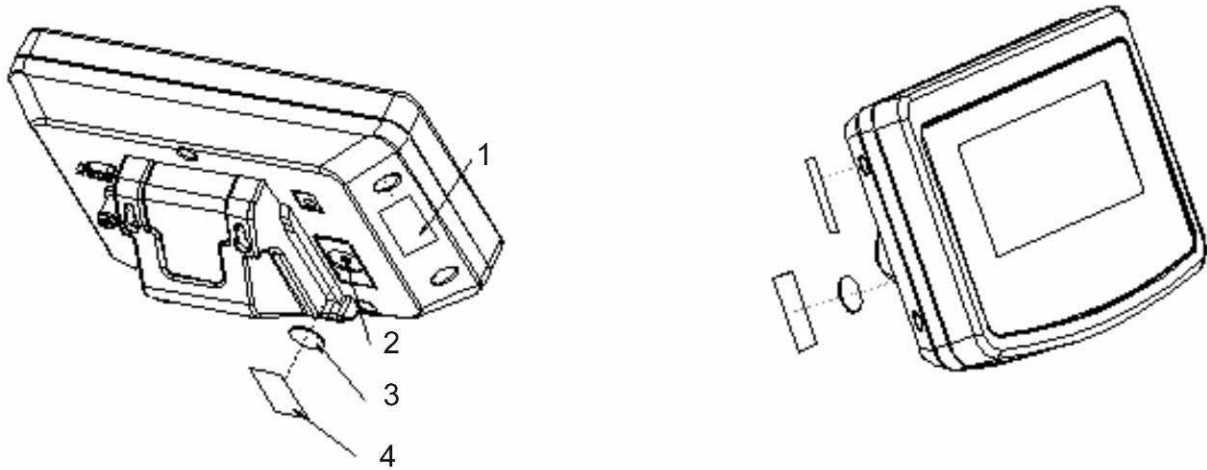

1. Self-destructing seal
2. Adjustment switch
3. Cover adjustment switch
4. Self-destructing seal

UFN:

Access to conductor plate:

- Remove seal
- How to open the display unit
- For adjustment / access the menu, the jumper [J] has to be set on both pins as shown in the picture.

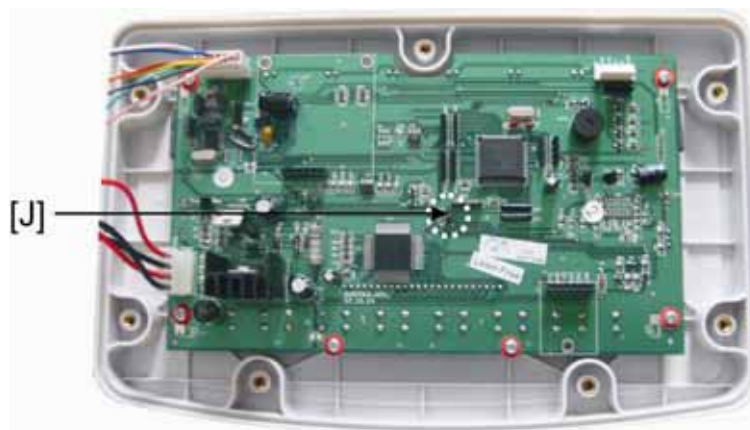

7 Operation

7.1 Start-up

- ⇒ Press , and the instrument will carry out a self-test.
The instrument is ready for weighing when a weight display appears.



7.2 Switching Off

- ⇒ Press  until the display disappears.

7.3 Zeroing

Resetting to zero corrects the influence of light soiling on the weighing plate.
Resetting range $\pm 2\%$ max.

The instrument comprises an automatic zero setting function, however, the instrument can be reset to zero whenever needed as described below.

- ⇒ Remove load from weighing system
- ⇒ Press , and the zero display as well as the **ZERO** indicator will appear.



7.4 Simple weighing

- ⇒ Place goods to be weighed on balance.
- ⇒ Wait for stability display **STABLE**.
- ⇒ Read weighing result.



Overload warning

Overloading exceeding the stated maximum load (max) of the device, minus a possibly existing tare load, must be strictly avoided. The instrument may be damaged by overloading.

Exceeding of maximum load is indicated by "----" as well as a signal sound.
Remove load from weighing system or reduce preload.

7.5 Weighing with tare

- ⇒ Deposit weighing vessel. After successful stop check press the  button. The zero display and the indicator **NET** appear.



The weight of the container is now internally saved.

- ⇒ Weigh the material, the net weight will be indicated.
- ⇒ The weight of the weighing container will be displayed as a minus number after removing the weighing container.
- ⇒ The tare procedure can be repeated as many times as necessary, for example with initial weighing of several components for a mix (add-on weighing). The limit is reached when the total weighing range capacity is full.

- ⇒ Switch between gross weight and net weight by pressing the  key.

- ⇒ To delete the tare value, remove load from weighing plate and press .

7.6 Weighing with tolerance range

You may determine an upper and lower limit for weighing with tolerance limits in order to ensure that the weighed load remains exactly within the fixed tolerance limits.

During tolerance checks such as dispensing, portioning and sorting, the instrument will indicate any lower deviation or exceeding of limits with the help of a visual signal or acoustic signal.

Acoustic signal:

The acoustic signal depends on the setting of the menu block "BEEP".

Options:

- no Acoustic signal turned off
- ok Acoustic signal sounds when load is within tolerance limits
- ng Acoustic signal sounds when load is beyond tolerance limits





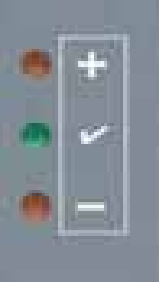

Optical signal:

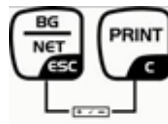





Three colour pilot lamps indicate whether load is within the two tolerance limits.
The signal lamps provide the following information:

	+	Goods to be weighed above tolerance limit	Red signal lamp glowing
	✓	Goods to be weighed within tolerance range	Green signal lamp glowing
	-	Goods to be weighed below tolerance limit	Red signal lamp glowing

Settings for tolerance weighing may be set either by calling up menu block “**P0 CHK**” (See chpt 8) or by applying the faster option of pressing the key combination



<h3>Settings</h3> <p>⇒ Press  and  at the same time in weighing mode.</p> <p>⇒ Press , the display used for entering the lower limit SET L appears.</p> <p>⇒ Press , current setting appears.</p> <p>⇒ Use the navigation keys (See chpt 2.1.1) for entering the lower limit, e.g. 1000 kg; the currently active digit will be flashing.</p> <p>⇒ Confirm input by .</p> <p>⇒ Select SET H using .</p>	
----------------------------------------------------------------------------------------------------------------------------------------------------------------------------------------------------------------------------------------------------------------------------------------------------------------------------------------------------------------------------------------------------------------------------------------------------------------------------------------------------------------------------------------------------------------------------------------------------------------------------------------------------------------------------------------------------------------------------------------------------------------------------------------------------------------------------------------------------------------------------------------------------------------------------------------	--------------------------------------------------------------------------------------

- ⇒ Press , and the current setting for the upper limit will be shown.
- ⇒ Use the navigation keys (See chpt 2.1.1) to set the upper limit, e. g. 1100 kg; the currently active digit will be flashing.
- ⇒ Confirm input by .
- ⇒ Select BEEP by .
- ⇒ Press , and the current setting for the acoustic signal will be shown.
- ⇒ Use  (no, ok, ng) to select the desired setting.
- ⇒ Confirm input by .
- ⇒ Press  and the weighing system will go into tolerance weighing mode. From here evaluation takes place whether the goods to be weighed are within the two tolerance limits.

Weighing with tolerance range

- ⇒ Tare, if using a weighing container.
- ⇒ Put on goods to be weighed, tolerance control is started

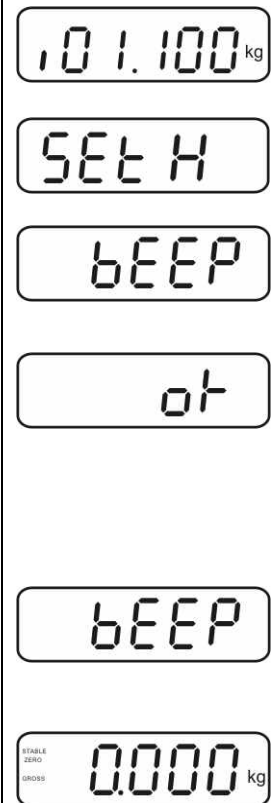

- The tolerance control is not active when the weight is under 20d.
- To delete limits enter a value of "00.000 kg".

7.7 Manual totalizing

With this function the individual weighing values are added into the summation memory by pressing  and edited, when an optional printer is connected.



- Menu settings:
„P1 COM“ ⇨ „MODE“ ⇨ „PR2““, s. Kap. 8
- The totalisation function is not active when the weight is under 20d.

Add up:

⇒ Place goods to be weighed A.

Wait until the stability display **STABLE** appears, then press . The weight value will be saved and a printout received if an optional printer is connected.



⇒ Remove the weighed good. More weighed goods can only be added when the display = zero.



⇒ Place goods to be weighed B.

Wait until the stability display appears, then press . The weight value will be added to the summation memory and possibly printed. The number of weighing processes followed by the total weight will be shown for 2 sec.





⇒ Add more weighed goods as described before.



Please note that the weighing system must be unloaded between the individual weighing procedures.

⇒ This process can be repeated until the capacity of the weighing system is exhausted.

Display of the saved weighing data:

⇒ Press  and the number of weighings followed by the total weight will be shown for 2 sec. To receive a printout, press  during this display.

Delete weighing data:

⇒ Press  and  at the same time. The data in the summation memory are deleted.







Printout example:

NO. 1	←	1
1.000kg		

NO. 2	←	2
0.500kg		

NO. 3	←	3
0.700kg		

total	←	4
NO. 3		
2.200kg		

- 1 First weighing 
- 2 Second weighing 
- 3 Third weighing 
- 4 Number of weighings / total  + 

7.8 Automatic adding-up

With this function the individual weighing values are automatically added into the summation memory when the balance is unloaded without pressing  and edited, when an optional printer is connected.



- Menu settings:
„P1 COM“ ⇒ „MODE“ ⇒ „AUTO““, see chpt 8
Indicator AUTO is displayed.



Add up:

- ⇒ Place goods to be weighed A.
After the standstill control sounds a signal tone. The weighing value is added to the summation memory, followed by printing.



- ⇒ Remove the weighed good. More weighed goods can only be added when the display \leq zero.
- ⇒ Place goods to be weighed B.
After the standstill control sounds a signal tone. The weighing value is added to the summation memory, followed by printing. The number of weighings, followed by the total weight, will be shown for 2 sec.



- ⇒ Add more weighed goods as described before.
Please note that the weighing system must be unloaded between the individual weighing procedures.
- ⇒ This process can be repeated until the capacity of the weighing system is exhausted.



Display and delete the weighing data, as well as printout examples see chpt. 7.7.

7.9 Animal weighing



The animal weighing function is ideal for unstable loads.

The weighing system calculates and displays a stable mean average from several weighing values.

The animal weighing program may either be enabled by calling up menu block "P3 OTH" ⇒ „ANM“ ⇒ „ON“ (See chpt 8) or by using the faster option of a key combination.



⇒ Place the load onto the weighing system and wait until it is fairly stable.

⇒ Press  and  at the same time, a signal sounds, meaning that the animal weighing function is enabled.

During the calculation of a mean average you can add or remove loads as the mean average will be continuously updated.

⇒ To disable the animal weighing function press  and  at the same time.

7.10 Lock keyboard

Go to menu item "P3 OTH" ⇒ „LOCK“, see chpt 8, and enable/disable the keyboard interlock. The enabled function will be locked after 10 minutes of inactivity. "K-LCK" will be displayed as soon as a key is pressed.

To cancel locking, keep pressed ,  and  at the same time (2s) until "U LCK" appears.

7.11 Display background illumination

⇒ Keep  pressed (3s) until "setbl" appears.

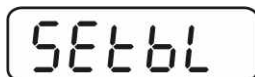

⇒ Press  again and the current setting will be displayed.

⇒ Use  to select desired setting.

bl on Background lighting is on continuously

bl off Background illumination off

bl Auto Automatic background illumination on when weighing plate is loaded

⇒ Enter by , using  save or cancel by .

7.12 Automatic switch-off function “AUTO OFF“

The instrument will switch off automatically after a set time when the display unit or weighing bridge has been idle.

⇒ Keep  pressed (3s) until “setbl“ appears.

SETbl

⇒ Call up **AUTO OFF** function using .

SETof

⇒ Press  current setting appears.

⇒ Use  to select desired setting.

of on AUTO OFF function disabled









of 5 Weighing system will switch off after 5 min

of 15 Weighing system will switch off after 15 min



⇒ Save entry by  or cancel using .

8 Menu

Navigation in the menu:

Call up menu	<p>⇒ Switch on instrument and press  during self-test.</p> <div style="text-align: center; border: 1px solid black; padding: 5px; width: fit-content; margin: 10px auto;">Pn</div> <p>⇒ Press in turn , ,  and the first menu block “PO CHK” will appear.</p> <div style="text-align: center; border: 1px solid black; padding: 5px; width: fit-content; margin: 10px auto;">POCHK</div>
Select menu block	<p>⇒ With help of , the individual menu items can be selected one after the other.</p>
Select setting	<p>⇒ Confirm selected menu item with . The current setting will be displayed.</p>
Change settings	<p>⇒ Use the navigation keys, see chpt 2.1 to switch between the available settings.</p>
Acknowledge setting / exit the menu	<p>⇒ Save entry by  or cancel using .</p>
Return to weighing mode	<p>⇒ To exit menu, press  repeatedly.</p>

Overview:

Menu block Main menu	Menu item Sub-menu	Available settings / definition		
PO CHK Weighing with Tolerance limits, see chpt 7.6	SET H	Upper limit, for entry see chpt 7.6		
	SET L	Lower limit, for entry see chpt 7.6		
	BEEP	no	Acoustic signal turned off for weighing with tolerance limits	
		ok	Acoustic signal sounds if load is within tolerance limits	
		ng	Acoustic signal sounds if load is beyond tolerance limits	
P1 COM Interface parameters	MODE	CONT	Continuous data output	
		ST1	One output for stable weighing value	
		STC	Continuous data output of stable Weighing values	
		PR1	Output after pressing 	
		PR2	Manual add-up, see chpt 7.7 After pressing  , weighing value will be added to summation memory and issued.	
		AUTO	Automatic add-up, see chpt 7.8 This function is used to automatically add and send individual weighing values to the summation memory whilst weighing instrument is being unloaded.	
		ASK	Remote control instructions: R, "read" T, "tare" Z, "zeroing"	
	BAUD	Available Baudrate 600, 1200, 2400, 4800, 9600		
	Pr	7E1	7 bits, even parity	
		7o1	7 bits, odd parity	
		8n1	8 bits, no parity	
	PTYPE	tPUP	Standard printer setting	
		LP50	Not documented	
P2 CAL Configuration data	COUNT	Display internal resolution		
	DECI	Position of the decimal dot		
	DUAL	Weighing scale type, capacity and readability (non-verified) or verification value (verified).		
	CAL	Adjustment, see chpt 6.7		
	GrA	Not documented		
P3 OTH see chap. 7.9 / 7.10	LOCK	on	Keyboard interlock enabled	
		off	Keyboard interlock disabled	
	ANM	on	Animal weighing enabled	
		off	Animal weighing disabled	

9 Service, maintenance, disposal

9.1 Cleaning

Before cleaning, disconnect the appliance from the operating voltage.

Please do not use aggressive cleaning agents (solvents or similar agents), but a cloth dampened with mild soap suds. Take care that the device is not penetrated by fluids and polish it with a dry soft cloth.

9.2 Service, maintenance

The appliance may only be opened by trained service technicians who are authorized by KERN.

Before opening, disconnect from power supply.

9.3 Disposal

Disposal of packaging and appliance must be carried out by operator according to valid national or regional law of the location where the appliance is used.

9.4 Error messages

Error message	Description	Possible causes
- - - - -	Maximum load exceeded	<ul style="list-style-type: none">Remove load from weighing system or reduce preload.
"Err 4"	Zeroing range exceeded due to switching-on balance or pressing (normally 4% max)	<ul style="list-style-type: none">Object on the weighing plateOverload when zeroingImproper adjustmentDamaged weighing cellDamaged electronics
"Err 6"	Value outside the A/D changer range	<ul style="list-style-type: none">Weighing plate not installedDamaged weighing cellDamaged electronics

Should other error messages occur, switch balance off and then on again. If the error message remains inform manufacturer.

10 Data output RS 232C

Standard features for display unit (**KERN UFB**) include an RS 232C interface. Weighing data can be edited according to menu setting or automatically or by pressing  via the interface.

This data exchange is asynchronous using ASCII - Code.

The following conditions must be met to provide successful communication between the weighing balance and the printer.

- Use a suitable cable to connect the moisture analyser to the interface of the printer. Faultless operation requires an adequate KERN interface cable.
- Communication parameters (baud rate, bits and parity) of display unit and printer must match. For detailed description of interface parameters see chpt 8, menu block „P1 COM“

10.1 Technical Data

Connector	25 pin d-subminiature bushing Pin 2 input Pin 3 output Pin 5 signal earth
Baud rate	600/1200/2400/4800/9600
Parity	8 bits, no parity / 7 bits, even parity / 7 bits, odd parity

10.2 Printer mode

- Standard printout “weighing data“

ST	Stable value
US	Instable value
GS	Gross weight
NT	Net weight
<lf>	Space line
<lf>	Space line

- Printout “summation memory“

<lf>		Space line
TOTAL NO:	3	Number weighing processes
TOTAL wgt.:	0.447KG	Total of all individual weighings

10.3 Continuous data output

con1: Weighing mode

		,			-/□								k	g	CR	LF
HEADER 1		HEADER 2		WEIGHT DATA								WEIGHT UNIT		TERMINATOR		

HEADER1: ST=STABLE, US=UNSTABLE

HEADER2: NT=NET, GS=GROSS

11 Instant help

In case of an error in the program process, briefly turn off the display unit and disconnect from power supply. The weighing process must then be restarted from the beginning.

Help:

Fault

Possible cause

The displayed weight does not glow.

- The display unit is not switched on.
- Mains power failure (mains cable defective).
- Power supply interrupted.
- (Rechargeable) batteries are inserted incorrectly or empty
- No (rechargeable) batteries inserted.

The displayed weight is permanently changing

- Draught/air movement
- Table/floor vibrations
- Weighing plate has contact with other objects.
- Electromagnetic fields / static charging (choose different location/switch off interfering device if possible)

The weighing result is obviously incorrect

- The display of the balance is not at zero
- Adjustment is no longer correct.
- Great fluctuations in temperature.
- Warm-up time was ignored.
- Electromagnetic fields / static charging (choose different location/switch off interfering device if possible)

Should other error messages occur, switch display unit off and then on again. If the error message remains inform manufacturer.