



GIMA

PROFESSIONAL MEDICAL PRODUCTS

VITAL SIGNS MONITOR

User Manual

REF 35132 / PC-900PLUS SNET



Shenzhen Creative Industry Co., Ltd.
Floor 5, BLD 9, BaiWangxin High-Tech Industrial Park,
Songbai Road, Xili Street, Nanshan District,
518110 Shenzhen, P.R. China
Made in China



Shanghai International Holding Corp. GmbH (Europe)
Eiffestrasse 80, 20537 Hamburg - Germany

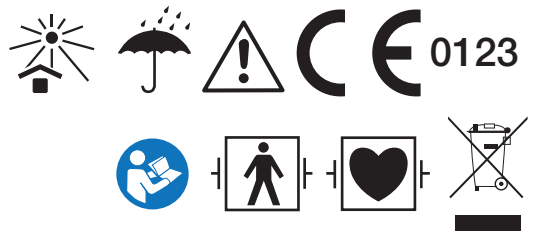

This Manual is written and compiled in accordance with the IEC 60601-1 (Medical electrical equipment Part1: General requirements for safety) and MDD 93/42/EEC. It complies with both international and enterprise standards and is also approved by State Technological Supervision Bureau. The Manual is written for the current Vital Signs Monitor.

The Manual describes, in accordance with the Vital Signs Monitor's features and requirements, main structure, functions, specifications, correct methods for transportation, installation, usage, operation, repair, maintenance and storage, etc. as well as the safety procedures to protect both the user and equipment. Refer to the respective chapters for details.

The Manual is published in English and we have the ultimate right to explain the Manual. No part of this manual may be photocopied, reproduced or translated into another language without the prior written consent. We reserve the right to improve and amend it any time without prior notice. Amendments will however be published in a new edition of this manual.

Version of This Manual: Ver 1.1



Revised Date: November 12th, 2019

Manufactured date: See label on device

Service life: 5 years

All rights reserved.

Marks in the Manual:

-  **Caution: must be followed to avoid endangering the operator and the patient.**
-  **Attention: must be followed to avoid causing damage to the monitor.**
-  **Note: some important information and tips about operations and application.**

Instructions to User

Dear Users,

Thank you very much for purchasing our product. Please read the following information very carefully before using this device.

Read these instructions carefully before using this monitor. These instructions describe the operating procedures to be followed strictly. Failure to follow these instructions can cause monitoring abnormality, equipment damage and personal injury. The manufacturer is NOT responsible for the safety, reliability and performance issues and any monitoring abnormality, personal injury and equipment damage due to user's negligence of the operation instructions. The manufacturer's warranty service does not cover such faults.

- ⚠ **WARNING-PACEMAKER PATIENTS.** This monitor may continue to count the pacemaker rate during occurrences of cardiac arrest or some arrhythmias. Do not rely entirely upon this monitor ALARMS. Keep pacemaker patients under close surveillance.
- ⚠ **Monitoring a single person at a time.**
- ⚠ **The monitor is defibrillator proof.** Verify that the accessories can function safely and normally and the monitor is grounded properly before conducting defibrillation.
- ⚠ **Disconnect the monitor and sensors before MRI scanning.** Use during MRI could cause burns or adversely affect the MRI image or the monitor's accuracy.
- ⚠ **If you have any doubt to the grounding layout and its performance, you must use the built-in battery to power the monitor.**
- ⚠ **All combinations of equipment must be in compliance with standard of IEC 60601-1-1 for medical electric system requirements.**
- ⚠ **Check SpO₂ probe application site periodically (every 30 minutes) to determine circulation, positioning and skin sensitivity.**
- ⚠ **The SpO₂ measurement of this monitor may not work for all testees. If stable readings can not be obtained at any time, discontinue use.**
- ⚠ **Do not immerse the monitor or its accessories in liquid to clean.**
- ⚠ **Do not use accessories other than those provided/recommended by the manufacturer.**
- ⚠ **Each time the monitor is used, check the alarm limits to ensure that they are appropriate for the patient being monitored.**
- ⚠ **The monitor is intended only as an adjunct in patient assessment. It must be used in conjunction with clinical signs and symptoms.**
- ⚠ **When taking the measure of an pediatric or neonate's (less than 10 years old) blood pressure, do NOT operate in the adult mode. The high inflation pressure may cause lesion or even body putrescence.**
- ⚠ **The monitor is prohibited from applying to those who have severe hemorrhagic tendency or who are with sickle cell disease for they may develop partial bleeding when this monitor is used to take the blood pressure measurement.**

- **DO NOT take blood pressure measurement from a limb receiving ongoing transfusion or intubation or skin lesion area, otherwise, damages may be caused to the limb.**
- **Continuous use of SpO₂ sensor may result in discomfort or pain, especially for those with micro-circulatory problem. It is recommended that the sensor should NOT be applied to the same place for over two hours, change the measuring site periodically if necessary.**
- **SpO₂ measuring position must be examined more carefully for some special patient. Do NOT install the SpO₂ sensor on the finger with edema or vulnerable tissue.**
- **To prevent the risk of the short circuit and to ensure the ECG signal quality, the equipment must be properly grounded.**
- **Although biocompatibility tests have been performed on all the applied parts, some exceptional allergic patients may still have anaphylaxis. Do NOT apply to those who have anaphylaxis.**
- **All the connecting cables and rubber tubes of the applying parts should be kept away from the patient's cervix to prevent any possible suffocation of the patient.**
- **All the parts of the monitor should NOT be replaced at will. If necessary, please use the components provided by the manufacturer or those that are of the same model and standards as the accessories along with the monitor which are provided by the same factory, otherwise, negative effects concerning safety and biocompatibility etc. may be caused. No modification of this device is allowed.**
- **If any operator requests more information such as circuit diagrams, parts list and product descriptions, for repairs carried out by qualified technical personal, please contact us.**
- **DO NOT stare at the infrared light of SpO₂ sensor when switch it on, for the infrared may do harm to the eye.**
- **If the monitor falls off accidentally, please do NOT operate it before its safety and technical indexes have been tested minutely and positive testing results obtained.**
- **It is recommended to take the blood pressure measurement manually. The automatic or continuous mode should be used at the presence of a doctor/nurse.**
- **Please peruse the relative content about the clinical restrictions and contraindication.**
- **When disposing of the monitor and its accessories, the local law should be followed.**
- **Substitution of a component different from that supplied might result in measurement error.**
- **It is recommended that the clinical operator regularly test device and accessories. And the visual and auditory alarm signals can be checked by intentionally disconnect accessories.**
- **Do not allow service or maintenance the device while used in patient.**
- **Please do not to position the device so that it is difficult to operate mains plug.**

Table of Contents

Chapter 1 Overview	1
1.1 Features	1
1.2 Product Name and Model.....	1
1.3 Intended Use.....	1
1.4 Safety	1
Chapter 2 Operating Principle	3
2.1 Conformation.....	3
Chapter 3 Installation and Connection	4
3.1 Appearance.....	4
3.1.1 Front Panel.....	4
3.1.2 Side Panel.....	9
3.1.3 Rear Panel	10
3.1.4 Underside of the Monitor	11
3.2 Battery Installation	11
3.3 Installation	123
3.3.1 Opening the Package and Check.....	13
3.3.2 Connecting the Power Supply.....	13
3.3.3 Starting the Monitor	13
3.4 Sensor Placement and Connection.....	14
3.4.1 ECG Cable Connection	14
3.4.2 Blood Pressure Cuff Connection	16
3.4.3 SpO ₂ Sensor Connection.....	19
3.4.4 TEMP Transducer Connection.....	21
3.4.5 Loading printer paper (if printer is installed).....	22
Chapter 4 Operations	25
4.1 Initial Monitoring Screen	25
4.2 Default Screen.....	25
4.3 Screen for Real-time ECG waveform (Optional).....	29
4.4 Screen Display for ECG Waveform Recall (Optional).....	30
4.5 NIBP List Screen (Optional).....	31
4.6 SpO ₂ Data List Screen (Optional).....	32
4.7 Alarm Event List Screen	32
4.8 Trend Graph Display (for HR Option)	33
4.9 Setup Menu Screen.....	34
4.9.1 ECG Setup (Optional)	35

4.9.2 SpO ₂ Setup (Optional).....	37
4.9.3 NIBP Setup (Optional).....	37
4.9.4 TEMP Setup (Optional).....	41
4.9.5 Patient Info.....	42
4.9.6 Nurse Call Setup.....	42
4.9.7 Network Setup.....	43
4.9.8 System Setup.....	44
4.10 Alarm Settings.....	45
Chapter 5 Alarm.....	46
5.1 Alarm Priority.....	46
5.2 Alarm Signal Generation.....	46
5.3 Alarm Reset and Silence.....	47
5.4 Alarm Settings.....	47
5.5 Verifying Alarm Function.....	48
Chapter 6 Technical Specifications.....	49
6.1 NIBP Monitoring.....	49
6.2 SpO ₂ Monitoring.....	49
6.3 Pulse Rate monitoring.....	49
6.4 TEMP Monitoring.....	49
6.5 Data Recording.....	50
6.6 Other Technical Specifications.....	50
6.7 Operating Environment.....	50
6.8 Classification.....	50
6.9 ECG Monitoring.....	50
6.10 Guidance and manufacturer's declaration-Electromagnetic compatibility.....	52
Chapter 7 Packaging and Accessories.....	56
7.1 Packaging.....	56
7.2 Accessories.....	56
Chapter 8 Monitoring Parameter.....	57
8.1 NIBP Monitoring.....	57
8.1.1 Measuring Principle.....	57
8.1.2 Factors affecting NIBP measuring.....	58
8.1.3 Clinical Limitations.....	58
8.2 SpO ₂ Monitoring.....	59
8.2.1 Measuring Principle.....	59
8.2.2 SpO ₂ Measurement Restrictions (interference reason).....	59
8.2.3 Low SpO ₂ measuring value caused by pathology reason.....	60

8.2.4 Clinical Limitations	60
8.2.5 Points to be noted in SpO ₂ and Pulse Measuring	60
Chapter 9 Troubleshooting	62
9.1 No Display on the Screen	62
9.2 No Blood Pressure and Pulse Oxygen Measures	62
9.3 Blank Printing Paper	62
9.4 System Alarm	62
Chapter 10 Maintenance	63
10.1 Service and Examination	63
10.1.1 Daily Examination	63
10.1.2 Routine Maintenance	63
10.1.3 Battery Maintenance	63
10.1.4 Service	64
10.2 Cleaning and Disinfection	64
10.3 Cleaning and Disinfection of Accessories	65
10.4 Storage	65
10.5 Transportation	65
Chapter 11 Appendix	66
11.1 Prompt information explanations	66
11.2 Default Alarming Values and Setup Range	67
11.3 Accessories List	68
11.4 Instructions for SpO ₂ Probe	69

Chapter 1 Overview

1.1 Features

This Vital signs monitor can be used to monitor patient's physiological parameters including ECG, heart rate (HR), non-invasive blood pressure (NIBP), oxygen saturation (SpO₂), Pulse rate (PR) and temperature. It has the following features:

- ✧ All parameters are displayed on big, bright color LCD;
- ✧ Touchscreen operation and key operation are available;
- ✧ Accurate NIBP measurement with hardware and software over-pressure protection, hemostat function is also available by cuff;
- ✧ Unique oximetry technique ensures sensitive and accurate SpO₂ and pulse rate measurement, pitch tone function is also available;
- ✧ Up to 12000 groups of BP measurements can be stored in non-volatile memory and reviewed by list;
- ✧ Up to 2000 groups of SpO₂, 30 hours of ECG waveform, and 2000 events can be stored;
- ✧ History data records can be reviewed in waveform, list or trend graph;
- ✧ All stored data can be uploaded to computer;
- ✧ Multi-level audible & visible alarm function, nurse call output is available;
- ✧ Network function for connecting to Central Monitoring System;
- ✧ Built-in printer is optional to print out waveform, and text information.

Note: The monitor you purchased may not cover all the mentioned functions according to its configuration.

1.2 Product Name and Model

Name: Vital Signs Monitor

Model: See label on page I

1.3 Intended Use

This Monitor is a multi-functional instrument designed for monitoring the vital physiological signs of adult and pediatric patients. With the functions of real-time recording and displaying parameters, such as ECG, non-invasive blood pressure, body temperature, functional oxygen saturation and so on, it allows comprehensive analysis of patient's physiological conditions.

This instrument is applicable for use in hospitals and clinical institutions. The operation should be performed by qualified personnel only.

Contraindication: please see chapter 8.

1.4 Safety

- a) This device conforms to the standard IEC 60601-1, with electric safety classification of Class I, BF and CF type of applied parts.

- b) This device can protect against the discharge of defibrillator and resist against the interference from electro-surgical unit.
- c) This device has the cardiac pace-maker pulse inhibition function.
- d) DO NOT use this device while the patient is under MRI or CT scanning.

Chapter 2 Operating Principle

2.1 Conformation

The Vital Signs Monitor is a product with modular design, it consists of ECG/TEMP module, NIBP module, SpO₂ module, main control unit, printer module (Optional), display panel, and power supply module etc. and the related accessories for ECG, NIBP and SpO₂ measurement.

☞ According to different configuration, you can order the device with necessary functions. Therefore, your monitor may not have all the monitoring functions and accessories.

1. The ECG/TEMP module detects the ECG signal through ECG cable/lead wires via electrodes, the heart rate is calculated from the ECG waveform data. The temperature is measured through the temperature probe.
2. The SpO₂ module detects and calculates pulse rate and functional oxygen saturation (SpO₂), and provides plethysmogram and perfusion index as well.
2. The NIBP module performs the measurement of blood pressure by non-invasive way of oscillometric technique, including the diastolic, systolic and mean arterial pressure. The cuffs are designed for adult, pediatric and neonate respectively.
3. The main control unit is in charge of LCD screen display, keyboard input, data storage, printing and networking function.

Chapter 3 Installation and Connection

3.1 Appearance

3.1.1 Front Panel

Model A: the Vital Signs Monitor without ECG function

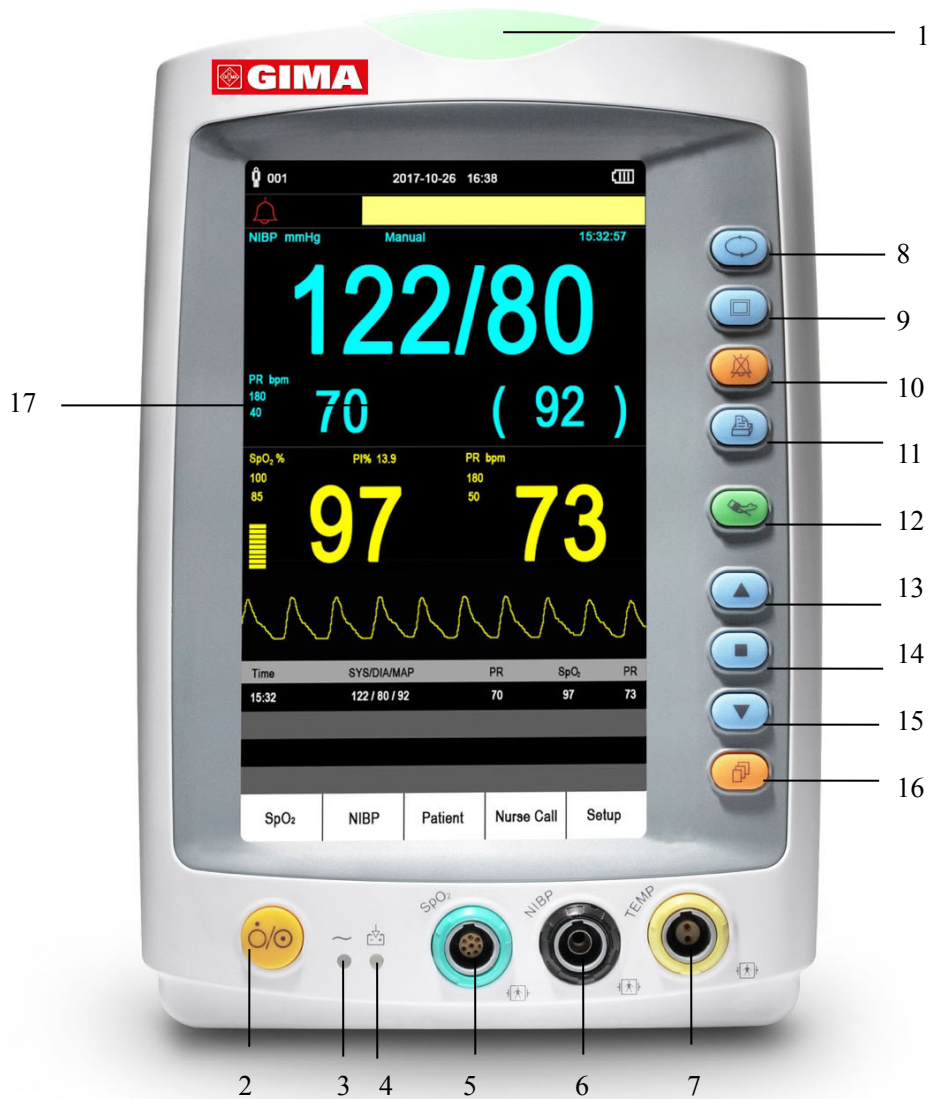





Figure 3.1A Front panel illustration for monitor (without ECG function)

Description:

1 "  "Alarm indicator











Indicator Color	Alarm Level
Red flashing	High priority alarm
Yellow flashing	Medium priority alarm

Yellow light	Low priority alarm
Green light	Normal

- 2 : Power button: Long pressing power button to start or shut off the monitor; Short pressing to enter into or exit from power saving mode.
- 3 : AC Power indicator.
- 4 : DC Power indicator.

Description to AC, DC Power indicator:

	AC Power indicator	DC Power indicator	Descriptions
Status	ON	ON	this device is on and using AC power supply
	OFF	ON	the device is on and using built-in battery
	ON	OFF	the device is off and battery is being charged while the AC power is connected.

- 5 **SpO₂**: SpO₂ sensor connector
- 6 **NIBP**: NIBP hose connector
- 7 **TEMP**: TEMP probe connector (optional)
- 8  **NIBP Setup key**: A shortcut key to change NIBP measuring mode and cycle time for Auto mode.
- 9  **Auxiliary key**: Holding this key and NIBP setup key (8) to lock or un-lock key operation. Short pressing this key can also enter into or exit from "Power Saving Mode".
- 10  **Alarm silence key**.
- 11  **Print**.
- 12  **NIBP Operation key**: Press it to start/cancel NIBP measurement.
- 13  **Up**: Shift cursor forward/upward.
- 14  **OK**: When in setting menu, press it to confirm selection or modification; On history record screen, long pressing this key, then a deleting dialog pops up; On monitoring screen, short pressing to freeze/unfreeze ECG waveform.
- 15  **Down**: Shift cursor backward/downward.
- 16  **Display View key**: Short pressing to shift LCD display views or return to the upper level screen; long pressing to enter into root setting menu display screen.
- 17 : **LCD panel**

Note: 1). : Type BF Applied Part with Defibrillation-proof

2). Long pressing means press and hold for 2 seconds.

3) BP value can be displayed in two units, "xxx" mmHg" or "xx.x" kPa, refer to section "4.7.2 NIBP Setup" to set the display unit of BP value. The conversion between two units is: 1kPa=7.5mmHg, 1mmHg=0.133kPa.

Model B: the Vital Signs Monitor with ECG function



Figure 3.1B Front panel illustration for monitor (with ECG function)

Description:

1 "  "Alarm indicator

Indicator Color	Alarm Level
Red flashing	High priority alarm
Yellow flashing	Medium priority alarm
Yellow light	Low priority alarm
Green light	Normal

2. "  ": **Power button:** Long pressing power button to start or shut off the monitor; Short pressing to enter into or exit from power saving mode.

3. ~: AC Power indicator.

4.  : DC Power indicator.

Description to AC, DC Power indicator:

	AC Power indicator	DC Power indicator	Descriptions
Status	ON	ON	this device is on and using AC power supply
	OFF	ON	the device is on and using built-in battery
	ON	OFF	the device is off and battery is being charged while the AC power is connected.

5. **SpO₂**: SpO₂ sensor connector

6. **NIBP**: NIBP hose connector

7. **TEMP**: TEMP probe connector (optional)

8. "" **NIBP Setup key**: A shortcut key to change NIBP measuring mode and cycle time for Auto mode.

9. "" **ECG lead selection key**: A short press of this key to shift ECG lead, holding this key and pressing NIBP setup key (8) will lock or un-lock the key operation.

10. "" **Alarm silence key**.

11. "" **Print**.

12. "" **NIBP Operation key**: Press it to start/cancel NIBP measurement.

13. "" **Up**: Shift cursor forward/upward.

14. "" **OK**: When in setting menu, press it to confirm selection or modification; On history record screen, long pressing this key, then a deleting dialog pops up; On monitoring screen, short pressing to freeze/unfreeze ECG waveform.

15. "" **Down**: Shift cursor backward/downward.

16. "" **Display View key**: Short pressing to shift LCD display views or return to the upper level screen; long pressing to enter into root setting menu display screen.

17. "": LCD panel

Note: 1). "": Type BF Applied Part with Defibrillation-proof

2). Long pressing means press and hold for 2 seconds.

BP value can be displayed in two units, "xxx" mmHg" or "xx.x" kPa, refer to section "4.7.2 NIBP Setup" to set the display unit of BP value. The conversion between two units is: 1kPa=7.5mmHg. 1mmHg=0.133kPa.

3.1.2 Side Panel

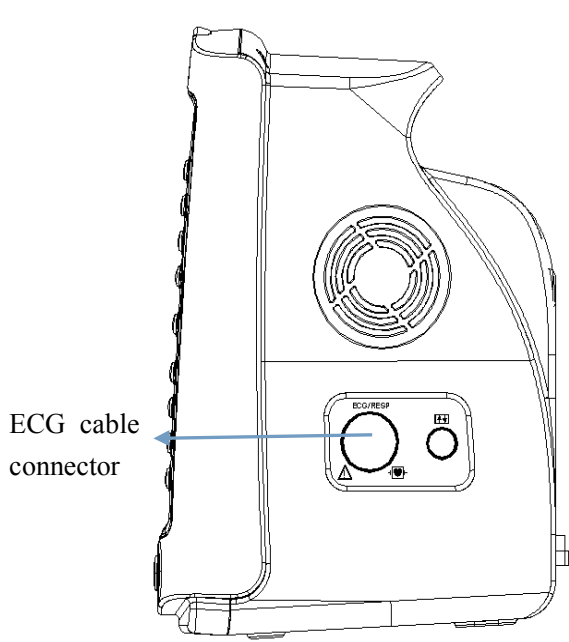

Figure 3.2 Right side of the monitor

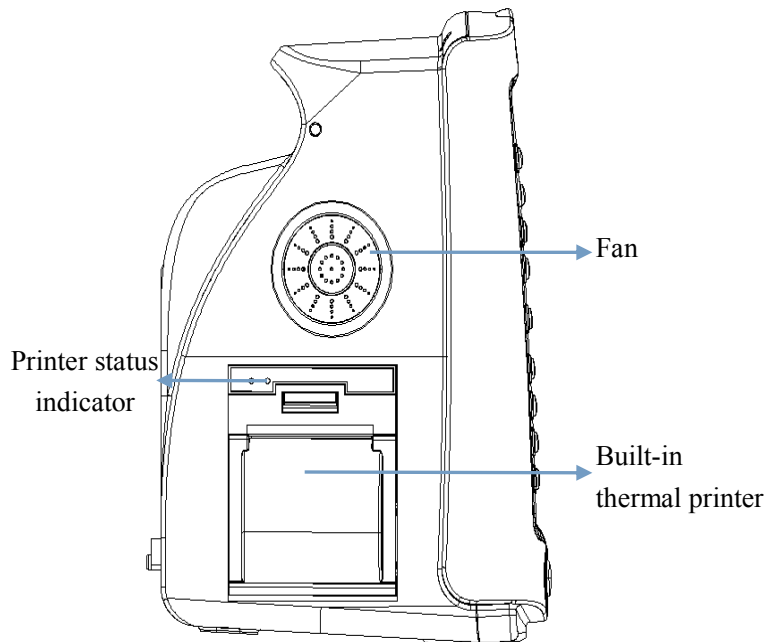



Figure 3.3 Left side of the monitor

The right panel of the monitor is as shown in figure 3.2.

- ◇  Symbol for CF type applied part with defibrillation-proof.
- ◇ ECG: ECG cable connector (Optional)
- ◇ "o": reserved port for future use.

The left panel of the monitor is as shown in figure 3.3.

The built-in thermal printer is in the left panel. It is easy for user to print waveform and data.

- ◇ : printer status indicator. One is for power indication of the printer, the green light shows the power is on, while the monitor is shut down, the green light is off. The other is for error indication, when the paper is empty or the printer is out of order, the red light is on.

3.1.3 Rear Panel

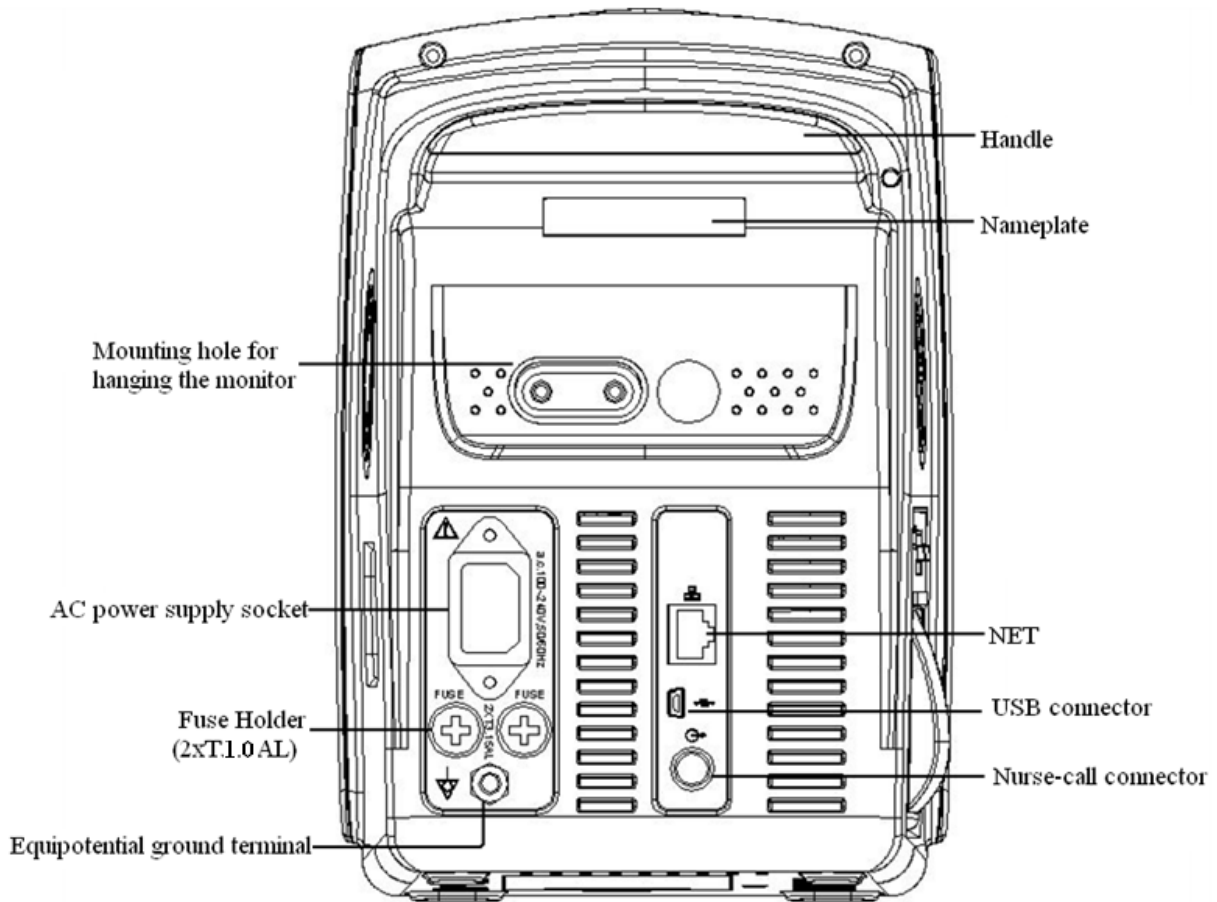

Figure 3.4 Rear Panel

The rear panel of the monitor is as shown in figure 3.4.

Form 3-1 Real panel Symbols and its descriptions

Symbol	Description	Symbol	Description
	Warning-- Refer to User Manual	FUSE 2XT1.0AL	Fuse holder
	USB connector		Equipotential terminal
	Network connector		Nurse-call connector

Fuse specification: T1.0AL/250V ϕ 5*20mm

3.1.4 Underside of the Monitor

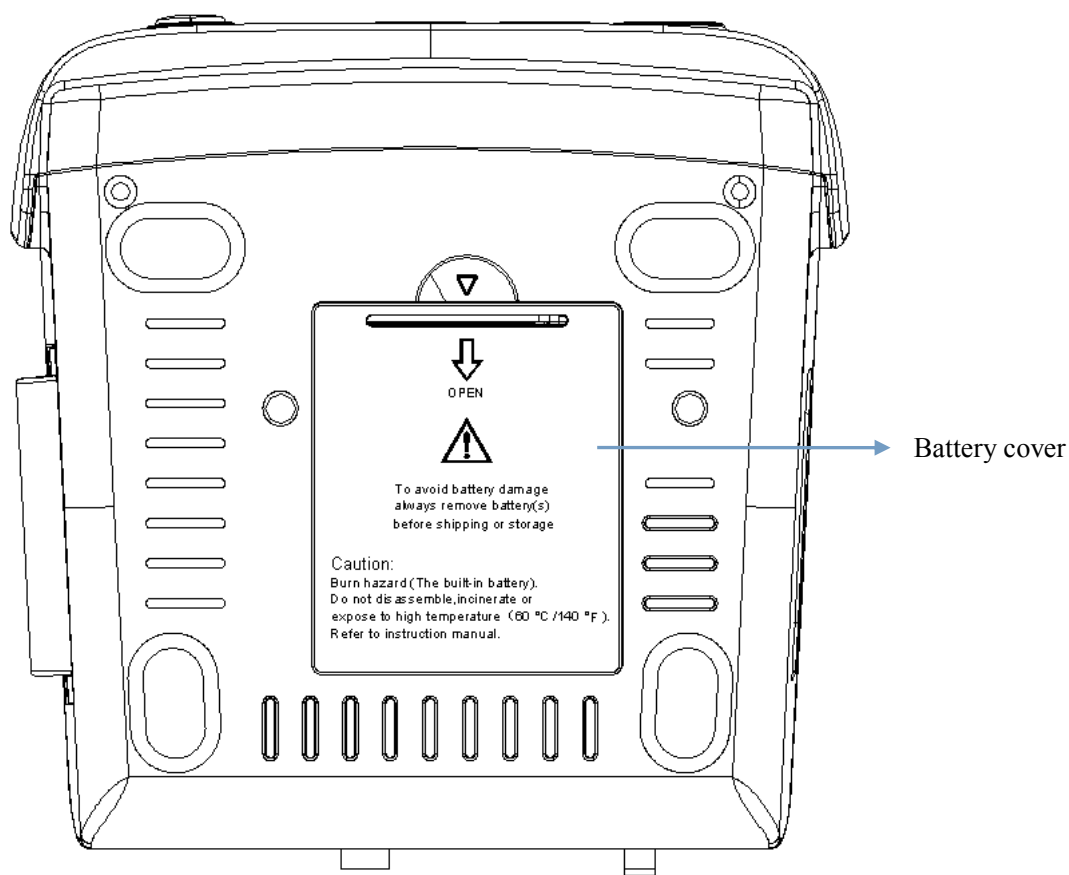

Figure 3.5 Underside of the monitor

3.2 Battery Installation

1. Ensure that the monitor is not connected to AC power supply and the monitor is turned off.
2. Open the battery cover and move the locking bar aside.
3. Put the battery into the box and move the locking bar back. Please note that the battery cables should be outward.
4. Connect the battery cable plug to the battery power socket in right direction, as shown in figure 3.6.
5. Arrange the wires and close the battery cover.

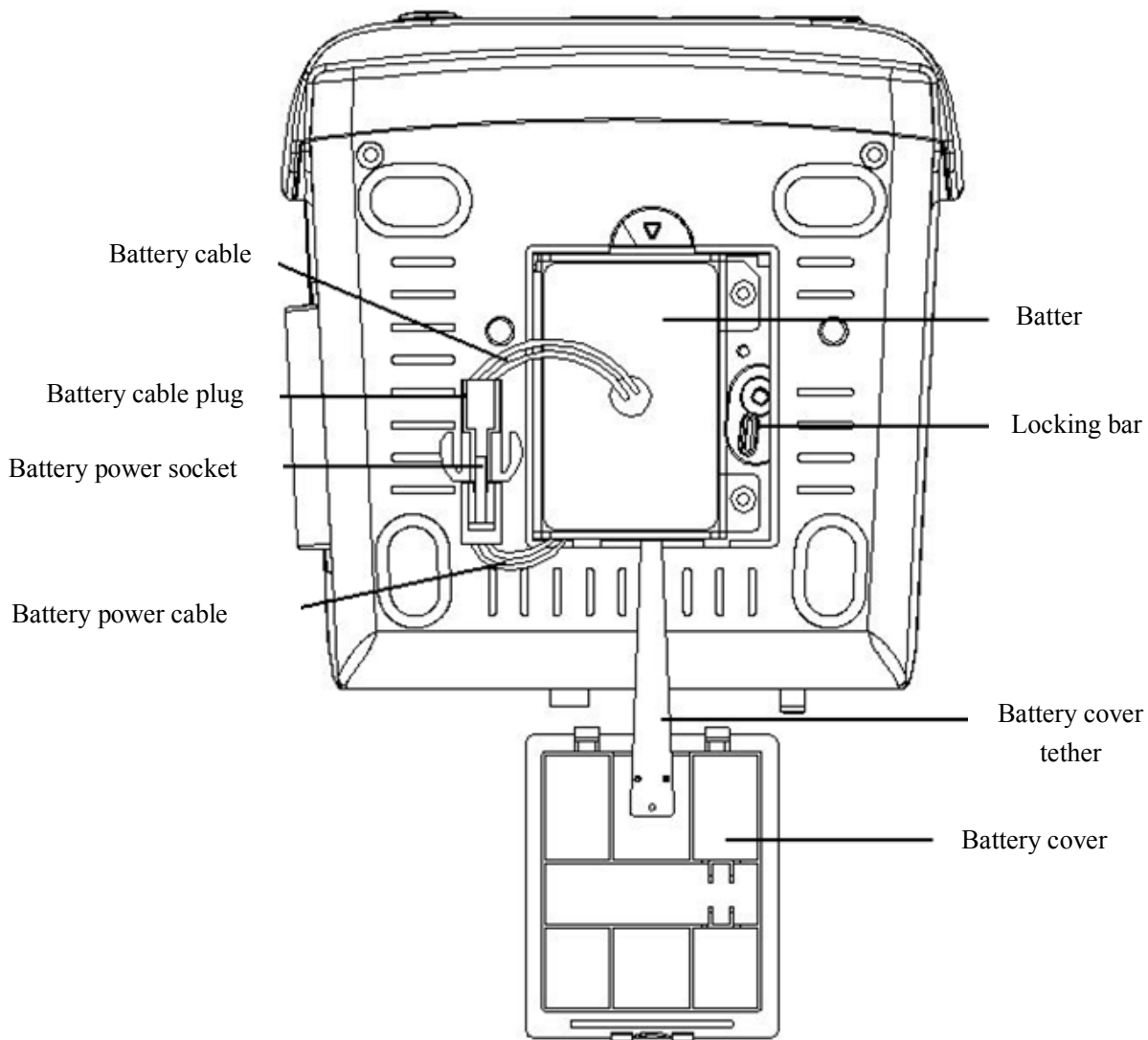

Figure 3.6 Battery Installation



Warning:

1. To avoid battery damage always remove battery(s) before shipping or storage.
2. It is recommended to use the battery specified by the manufacturer.
3. The battery service life depends on how frequent and how long it is used. For a properly maintained and stored lead-acid or lithium battery, its service life is about 2 or 3 years respectively. For more aggressive use models, service life can be less. We recommend replacing lead-acid battery every 2 years and lithium battery every 3 years.

Caution:

1. Keep the battery out of the reach of children.
2. Do not disassemble battery.
3. Do not dispose of them in fire.
4. Do not cause them to short circuit.

3.3 Installation

3.3.1 Opening the Package and Check

1. Open the package, take out the monitor accessories from the box carefully and place it in a safe stable and easy to watch position.
2. Open the accompanying document to sort the accessories according to the packing list.
 - ◆ Inspect the monitor for any mechanical damages
 - ◆ Check all the accessories for any scratch or deformity, especially on connector, wire and probe parts

☞ You can customize the module configuration by choosing necessary modules to meet your own needs. Therefore, your monitor may not have all the monitoring functions and accessories.

If in doubt, please contact the local dealer or our company in case of any problems. We are to offer you the best solution for your satisfaction.

3.3.2 Connecting the Power Supply

1. When powered by AC mains power supply:

- ◆ Make sure that the AC power supply is 100-240VAC, 50/60Hz.
- ◆ Use the power cable prepared by the manufacturer. Insert one end of it to the power port of the monitor and the other end to the grounded three-phase power jack.
- ◆ To eliminate potential differences, the monitor has a separate connection to the equipotential grounding system. Connect one end of the provided ground cable to equipotential grounding port on the rear of the monitor, and connect the other end to one point of the equipotential grounding system.

Caution: ensure that the monitor is grounded correctly.

- 🔔 After the supply mains has been interrupted when power switch remains in the “on” position and is restored after a period of time that is longer than 30 seconds, the monitor will run by the last settings when restarting the monitor.

2. When powered by built-in battery

- ◆ Caution: it's better to recharge the battery after it is used up, the charging time should be 13~15 hours long.
- ◆ The provided battery of the monitor must be recharged after transportation or storage. So if the monitor is switch on without being connected to the AC power socket, it may not work properly due to insufficient power supply.

3.3.3 Starting the Monitor

The system performs self-test and enters initial display after switching on the monitor, and the orange alarm indicator blinks to inform that the user can begin operating it.

- ◆ Check all the applicable functions to make sure that the monitor works normally.
 - ◆ If the battery is applied please recharge it after using the monitor to ensure sufficient power storage. It will take minimal 8 hours to charge battery from depletion to 90% charge.
- 🔔 Do not use the device to monitor the patient if there are indications of damage or reminders of error. Please contact the local dealer or our company.

- 🔔 It's recommended to delay 1 minute to start it again.
- 🔔 The subsequent operation of the device after interruption of the SUPPLY MAINS exceeding 30 s.

3.4 Sensor Placement and Connection

3.4.1 ECG Cable Connection

ECG measurement is to collect the ECG signal via the ECG electrodes. Electrode connects the patient and the lead. The lead connects the monitor. The locations of the electrodes are very important for obtaining accurate ECG signals.

1. Connect the cable to the right-panel connector marked with the ECG icon.
2. Select electrodes to be used. Use only one type of electrode on the same patient to avoid variations in electrical resistance. For ECG monitoring, it is strongly recommended to use silver/silver chloride electrodes. When dissimilar metals are used for different electrodes, the electrodes may be subject to large offset potentials due to polarization. Using dissimilar metals may also increase recovery time after defibrillation.
3. Prepare the electrode sites according to the electrode manufacturer's instructions.
4. Skin clean
 - Clean and dry-abrade skin to ensure low sensor impedance. Mild soap and Water is recommended as a skin cleanser.

Note: Alcohol is not recommended as a skin cleanser; it leaves a film layer that may cause high sensor impedance. If alcohol is used, ensure 30-second dry time.

- Dry-abrading the skin gently with a dry wash cloth, gauze, or skin preparation product is helpful to remove the non-conductive skin layer.



The symbol indicates that the cable accessories are designed to have special protection against electric shocks, and is defibrillator proof.

The locations of the electrode are in the following Figure:

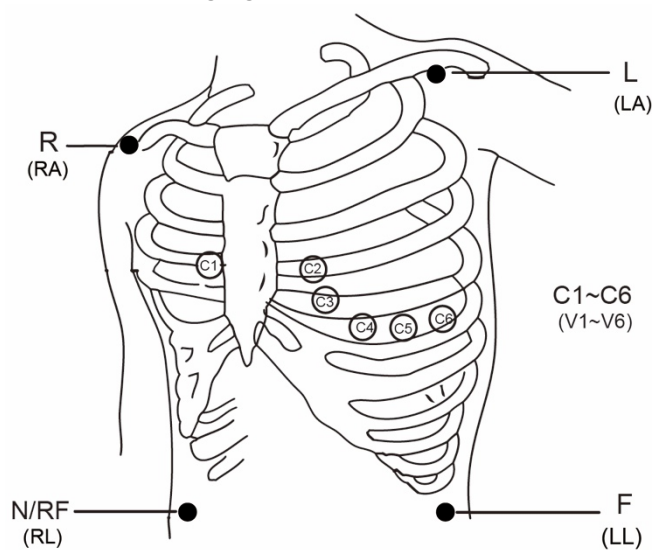

Figure 3.7A Electrode Location

Note: If skin rash or other unusual symptoms develop, remove electrodes from patient.

5. After starting the monitor, if the electrodes become loose or disconnected during monitoring, the system will display "LEAD OFF" on the screen to alarm the operator.

6 The ECG leads and their corresponding locations are as follows:





Table 3-2

Lead connection 1 (IEC standard)		Lead connection 2 (AHA standard)		Electrode placement
Color	Electrode label	Color	Electrode label	
Red	R	White	RA	Place on the right arm, or the intersection between the centerline of the right clavicle and Rib 2
Yellow	L	Black	LA	Place on the left arm, or the intersection between the centerline of the left clavicle and Rib 2
Green	F	Red	LL	Place on the left leg, or left part of the upper abdomen
Black	N or RF	Green	RL	Place on the right leg, or right part of the upper abdomen
White	C	Brown	V	An individual and movable electrode pasted on the chest
White or Red	C1	Brown	V1	On the 4th intercostal space at right border of sternum
White or Yellow	C2	Brown or Yellow	V2	On the 4th intercostal space at left border of sternum
White or Green	C3	Brown or green	V3	The middle line between V2 and V4
White or brown(Blue)	C4	Brown or blue	V4	The intersection between the centerline of the clavicle and the 5th intercostal
White or Black	C5	Brown or Red	V5	The intersection between the left anterior axillary line and the horizontal level of V4
White or Purple	C6	Brown or purple	V6	The intersection between the left mid-axillary line and the horizontal level of V4

Safety Instructions for ECG Monitoring

- Use the same type electrode on a patient. If skin rash or other unusual symptom occurs, remove electrodes from patient. Do not attach electrodes on the patient with an inflammation of the skin or scores on skin.
- 🔔 Vital Signs Monitor can only be equipped with ECG leads provided by our company; using ECG leads supplied by other companies may cause improper performance or poor protection while using defibrillator.
- 🔔 Electric parts of electrodes, leads and cable are forbidden to contact any other conductive parts (including ground).
- 🔔 Vital Signs Monitor can resist against defibrillator and electro-surgical unit. Readings may be inaccurate for a short time after or during using defibrillator or electro-surgical unit.
- 🔔 Transient caused by cable circuitry blocks while monitoring may be similar to the real heartbeat waveform, as a result resistance heart rate alarm rings. If you put the electrodes and cable in proper places according to this manual's instructions and the instructions for using electrode, the chance of this transient occurring will be decreased.
- Besides the improper connection with electro-surgical unit may cause burns, the monitor may be damaged or arouse deviations of measurement. You can take some steps to avoid this situation, such as do NOT use small ECG electrodes, choosing the position which is far away from the estimated Hertzian

waves route, using larger electro-surgical return electrodes and connecting with the patient properly.

-  ECG leads may be damaged while using defibrillator. If the leads are used again, please do the functional check first.
-  When removing the ECG cable, hold the head of the connector and pull it out.
-  When the monitor is inoperable due to an overload or saturation of any part of the amplifier, it will prompt "Lead off" to remind operator.
-  No predictable hazard will be caused by the summation of leakage currents when several item of monitor are interconnected.
-  Cardiac pacemaker pulse inhibition function is available while calculating heart rate, this function is always effective on all filter settings for ECG monitoring and it can not be disabled by user.







3.4.2 Blood Pressure Cuff Connection

1. Connect the cable to the right-panel connector marked with the NIBP icon.
2. Select the appropriate cuff (see below) and wrap around the patient's upper arm.

Cuff requirements:

- 1) An appropriate cuff should be selected according to the size of the subject. The cuff width should be 2/3 of the length of the upper arm. The cuff inflation part should be long enough to permit wrapping 50-80% of the limb concerned.

Note: The size of the cuff selected should suit the patient while measuring.

-  When putting on the cuff,, wrap it around the upper arm evenly to appropriate tightness.
- 2) Remember to empty any residual air in the cuff before the measurement commences.
 - 3) Locate the cuff in such a way that the "φ" mark is at a location where the clearest pulsation of brachial artery is observed.
 - 4) The cuff should be tightened to a degree where insertion of one finger is possible.
 - 5) The lower end of the cuff should be 2cm above the elbow joint.
3. Patient position while taking the blood pressure measurement for correct result:
 -  Comfortably seated
 -  Leg uncrossed
 -  Feet flat on the floor
 -  Back and arm supported
 -  Middle of the Cuff at the level of the right atrium of the heart

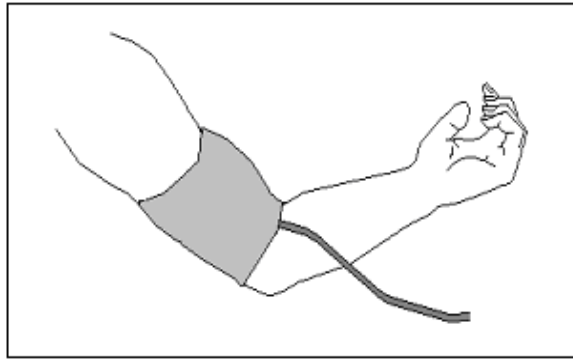

Figure 3.7B Cuff Placement

◆ **Pressure Accuracy Verification**

Pressure Accuracy Verification is a function to inspect the accuracy of pressure measurement by the NIBP module inside the device. Technician or equipment manager should do pressure accuracy verification every half year or year in order to check if the pressure measurement still conforms to the requirement of product performance. If the deviation is beyond the declared specification, it is permitted to return it to factory for repair or calibration.

Before verification, please connect the monitor to a precise pressure meter such as a mercury pressure mete, which is used as the reference meter.

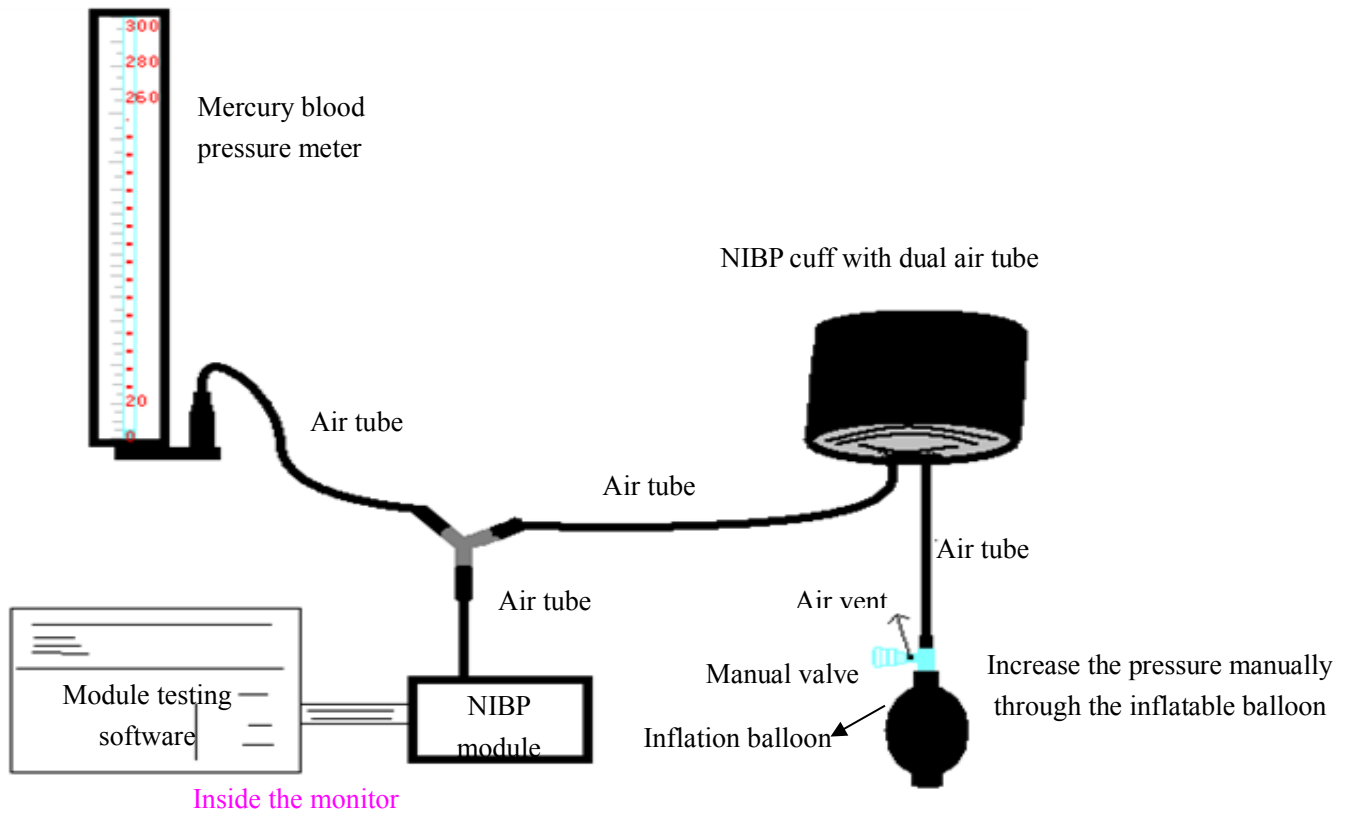

Figure 3.8 Connection of Pressure calibration fixture

Mode 1: Automatic inflation

The inflation can be activated by Monitor so the pressure will increase automatically until it exceeds the limit value specified in table A. This pressure limit value depends on the patient type selection as shown in table A:

Adult	240mmHg
Pediatric	200mmHg
Neonate	120mmHg

Table A



During inflation, the Monitor will close the deflation valve, and pressure reading will be shown as inflation takes place. If there is no manual deflation operation, the pressure will persist until deflation by the manual valve. It is necessary to deflate in several steps to verify the pressure accuracy at points across the full scale measurement range.

Mode 2: Manual inflation.

Increase the pressure manually by the inflation balloon, and the verification can be done by applying different pressures manually. If the increased pressure exceeds the given limit as shown in table B, the Monitor will deflate automatically because of the over-pressure protection valve in each mode.

Adult	300mmHg
Pediatric	240mmHg
Neonate	150mmHg

Table B

-  **After verification, press the button again to return to normal working mode and continue operation, or the NIBP key will be invalid.**
-  **Pressure accuracy verification should be undertaken by a technician or equipment manager and never with the BP cuff still on a patient.**

◆ Air Leakage Check

In order to avoid measurement errors or even no measurement result caused by air leakage in the pneumatic system including the cuff during measuring, it is recommended to check if there is leak in the pneumatic system as well.

-  **Please remove the cuff from patient while performing the leakage check.**

Safety Instructions for NIBP Monitoring

- When taking the NIBP measurement of a pediatric or neonate's (less than 10 years old), do NOT operate in the adult mode as the high inflation pressure may cause lesion or even body putrescence.
- It is recommended to take the blood pressure measurement manually. Automatic measurement should be used at the presence of a doctor/nurse.
- NIBP monitoring is prohibited to those who have severe hemorrhagic tendency or with sickle cell disease, or partial bleeding will appear.
- Manual blood pressure measurement is recommended or the automatic measurement used in the presence of a clinician.
- Confirm your patient category (adult, pediatric or neonate) before measurement.
- Do NOT use the NIBP cuff on limbs with transfusion tubes, intubation or skin lesions, otherwise, damages may be caused.
- If automatic blood pressure measurement is set for too long, the limb connected to the cuff may possibly experience purpura, lack of blood and neuralgia. In order to protect patient, it is requested to

inspect the luster, the warmth and sensitivity of the body extremity frequently. On observation of any abnormality, immediately stop the blood pressure measurement.

- ✧ The patient should relax as much as possible during the measurement.
- ✧ It's recommended that the 5min should elapse before starting the first measurement.
- The patient should lie in bed or sit in a chair, in order for the cuff and the heart to be at the same level and the most accurate measurement to be taken. Other postures may lead to inaccurate measurement.
- Do not speak or move before or during the measurement. Ensure that the cuff will not be hit or touched by other objects.
- The measurements should be taken at appropriate intervals. Continuous measurement at too frequent intervals may lead to compression of the arm, reduced blood flow and lower blood pressure, and result in inaccurate measurement of blood pressure. Two minutes measurement intervals are recommended.
- When an adult is monitored, the machine may fail in giving the blood pressure measure if the pediatric mode is selected.
- Prior to use of the cuff, empty the cuff until there is no residual air inside it to ensure accurate measurement.
- Do NOT twist the cuff tube or put heavy things on it.
- ✧ When unplugging the cuff, hold the head of the connector and pull it out.
- ✧ When the monitor is used with electro-surgical unit, do not allow the cuff, bladder and air tube contact any part of the electro-surgical unit to prevent the patient from hurt caused by burning.
- ✧ Make sure that the device is used in the environment specified on this User Manual, or inaccuracy result may be caused.



The symbol indicates that the cable and accessories are designed to have special protection against electric shocks, and is defibrillator proof.

3.4.3 SpO₂ Sensor Connection

The SpO₂ sensor is very delicate. Please follow the steps and procedures below when using it as failure to do so correctly can cause damage to the SpO₂ sensor.

The reusable SpO₂ finger clip sensor can be used with a compatible monitor (e.g. all models of Monitors made by us).

Operation procedure:

1. Connect the SpO₂ sensor to the connector labeled "SpO₂". **When unplugging the probe, be sure to hold the head of the connector and pull it out.**
2. If the finger clip SpO₂ sensor is used, insert one finger into the sensor (index finger, middle finger or ring finger with short nail length) as shown in the figure below.

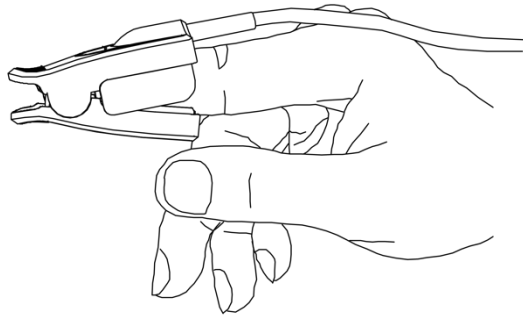

Figure 3.9 Finger clip SpO₂ sensor placement

When selecting a sensor, consider the patient’s category, adequacy of perfusion, availability of probe site and anticipated monitoring duration. Use only SpO₂ probes provided by our company with this monitor. Read the following table for SpO₂ probe information. Refer to Chapter 11.5 for the detailed instructions of each SpO₂ probe.

SpO ₂ Probe	Patient Category
SpO ₂ Finger Rubber Sensor(reusable)	Adult
SpO ₂ Finger Clip Sensor(reusable)	Adult

3. If the neonate SpO₂ sensor is used, please follow Figure 3.10 to connect.

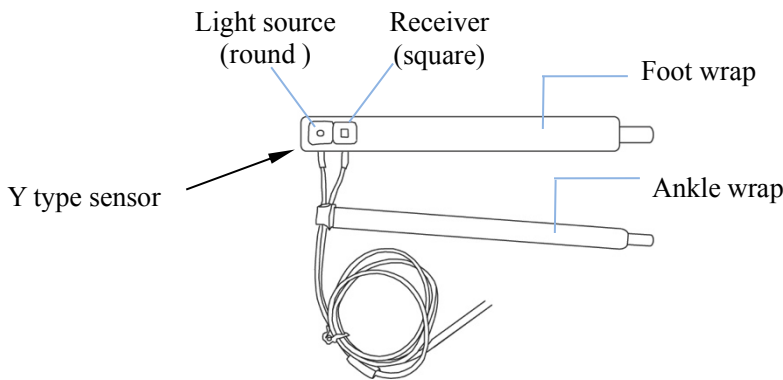

Figure 3.10A Neonate SpO₂ sensor placement

① For proper placement on foot, place the sensors on the outside of the foot behind the pinky toe. Make sure the sensor touch the skin closely, then secure the foot wrap with Velcro (see Figure 3.10B and 3.10C). Do not over-tighten.

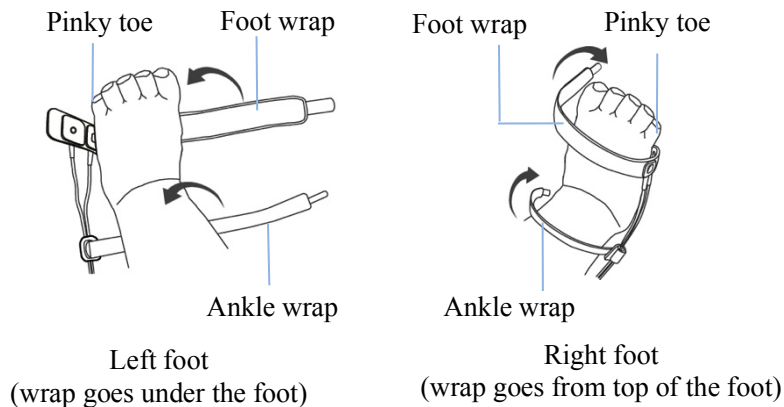

Figure 3.10B

- ② Use the ankle wrap to secure the sensor cable on the ankle or leg (see Figure 3.10C). Do not over-tighten.

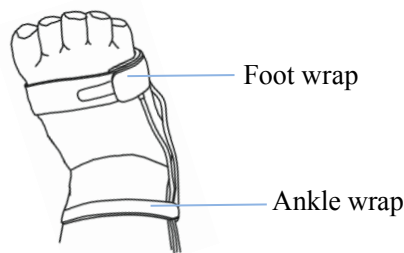

Figure 3.10C Right foot view

High ambient light sources such as surgical lights (especially those with a xenon light source), bilirubin lamps, fluorescent lights, infrared heating lamps, and direct sunlight can interfere with the performance of a SpO₂ sensor. To prevent interference from ambient light, ensure that the sensor is properly applied, and cover the sensor site with opaque material.

Failure to take this action in high ambient light conditions may result in inaccurate measurements.

If patient movement presents a problem, verify that the sensor is properly and securely applied; move the sensor to a less active site; use an adhesive sensor that tolerates some patient motion; or use a new sensor with fresh adhesive backing.

For reusable sensors, follow the sensor directions for use for cleaning and reuse. For single-patient use sensors, use a new sensor for each patient. Do not sterilize any sensor by irradiation, steam, or ethylene oxide.

Safety Information for SpO₂ Monitoring

- ☛ Continuous use of the SpO₂ sensor may result in discomfort or pain, especially for those with microcirculatory problem. It is recommended that the sensor should NOT be applied to the same place for over two hours, change the measuring site periodically if necessary.
 - The SpO₂ measuring site must be examined carefully for certain patient groups. Do NOT place the SpO₂ sensor on the finger of a patient with edema or fragile tissue.
- 🔔 If sterile packaging of a disposable SpO₂ sensor is damaged, do not use it.
- 🔔 Check the SpO₂ sensor and cable before use. Do NOT use a damaged SpO₂ sensor.
- 🔔 If the temperature of SpO₂ sensor is abnormal, do not use it any more.
- ☛ Please do not allow the cable to be twisted or bent.
- ☛ Do NOT put the SpO₂ sensor and pressure cuff on the same limb, otherwise the NIBP measuring will affect SpO₂ measuring and cause an alarm error.
- ☛ Using nail polish or other cosmetic product on the nail may affect the accuracy of measurement.
- ☛ The fingernail should be of normal length.
- ☛ The SpO₂ sensor cannot be immersed in water, alcohol or cleanser completely, because the sensor has no capability to resist the harmful ingress of water.
- ☛ For the range of the peak wavelengths and maximum optical output power of the light by the SpO₂ sensor, see Chapter 6. And this information can be especially useful to clinicians.
- ☛ When the SpO₂ signal inadequate, the screen will display "--", even a technical alarm will be generated. And all SpO₂ waveform are NORMALIZED.

3.4.4 TEMP Transducer Connection

Please follow the corresponding methods to make temperature measurement according to the temperature transducer you selected.

◆ **Connecting methods for thermal temperature transducer:**

1. Securely attach the transducer to the patient;
2. Connect the cable to TEMP probe connector in the front panel.

◆ **Connecting methods for infrared temperature probe:**

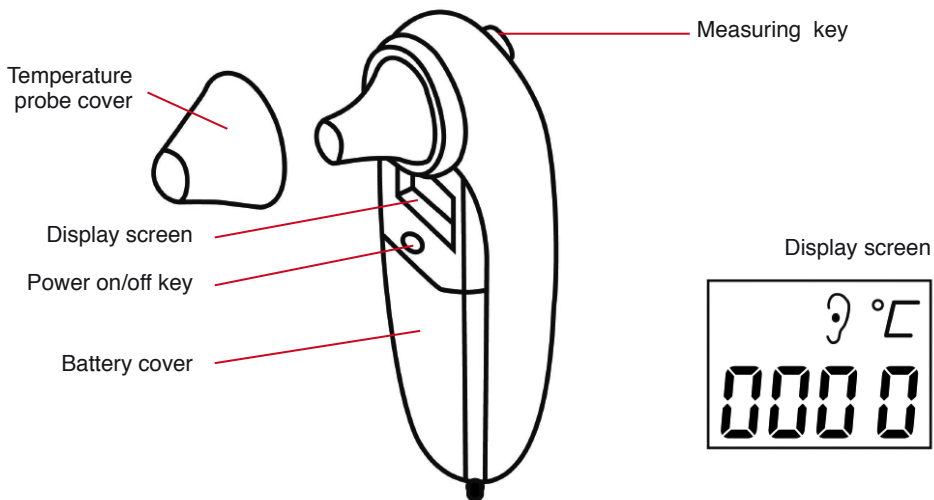

Figure 3.11 A

Figure 3.11 B

- Connect the infrared temperature probe to the connector on the front side of device marked "TEMP".
- When the probe screen shows as figure 3.11B and the temperature unit "°C" is blinking, the user can begin to take the measurement.
- Insert the tip of the temperature probe into the earhole and press the measuring key to start the measurement. A short beep means the measurement has finished and the result will be displayed on the both probe and the monitor screen .

Note: When unplugging the probe, be sure to hold the head of the connector and pull it out.

3.4.5 Loading printer paper (if printer is installed)

Operation procedures for loading printer paper:

1. To open the printer cover, press two thumbs firmly on both "OPEN" notches.
2. Move the tab of the left rubber roller lock 90° upwards to unlock it, refer to the following figure with mark ①.
3. Cut one end of the paper into a triangle, and load the paper from the underside of the rubber roller.
4. Turn the roller clockwise to roll the paper rolled, and put the paper roll into the compartment.
5. Pull the paper out of the paper slot on the shield.
6. Move the tab of the rubber roller lock 90° downwards to lock it.
7. Put the shield back in position and secure it.

Operation procedures for taking out printer paper roll:

- Steps 1~2: Same as above.
- Steps 3. Roll the loading roller anti-clockwise and pull the paper out.
- Steps 4~5: As steps 6~7 above.

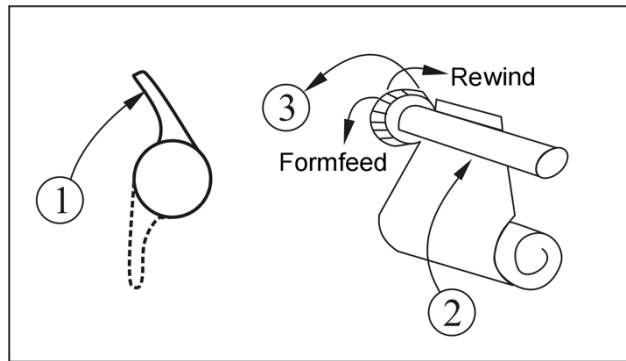

Figure 3.12 Loading and taking out printer paper

P8 printer may be used due to the different configuration

P8 printer operation instruction:

Power indicator: green light shows the power is on, when the monitor is out of power, the green light is off.

Error indicator: red light which shows the printer is out of paper or the printer paper is not properly installed.

When the printer successfully installs, the red light is off.



Figure 3.13 P8 printer

Loading printing paper:

Step 1: Press and hold down the cartridge button to open the paper cartridge;

Step 2: Install the paper to the printer properly, pull the paper out of the printer for 2 cm, as shown in figure 3.14.

Step 3: Close the printer cover along the direction of arrow, as shown in figure 3.14.



Figure 3.14 Printing paper

Chapter 4 Operations

This chapter mainly introduces display screen and operating instruction, including initial screen, default screen, system menu, menu setup and data upload. Before operating the monitor, please refer to the related section for accessories connection.

Note: The monitor you purchased may not cover all the mentioned functions according to its configuration.

4.1 Initial Monitoring Screen

Long pressing (about 2 seconds) "⏻" power key, when you hear one "beep", the LCD will display the following figure, it means that the monitor is started successfully, as shown in figure 4.1.



Figure 4.1 Startup screen

Short pressing power key "⏻" can switch between power saving modes and full power mode. Power saving modes mean the LED and LCD display become darker, the brightness has two levels.

Long pressing power key "⏻" again, the display will turn to black, it means that the monitor is shut down successfully.

4.2 Default Screen

When the monitor is powered on, the default display screen is as shown in figure 4.2.

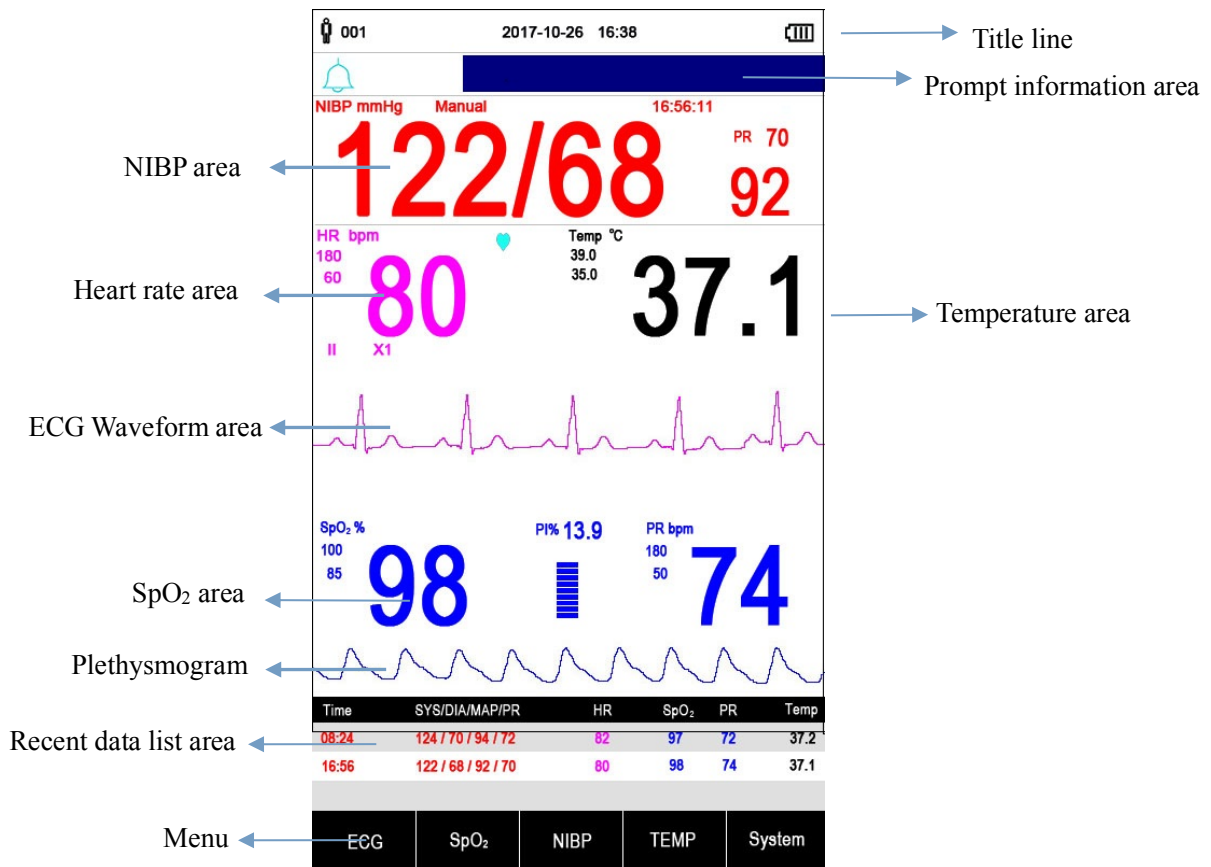

Figure 4.2A Default monitoring screen (monitor with ECG function)

Title line:

- ✧ "Adult 001": the patient type and ID number of the patient being monitored currently.
- ✧ "2017/10/26 16:38": the current date and time, year/month/day hour:minute.
- ✧ " [Battery Icon] ": battery voltage indicator.
- ✧ " [Key-Lock Icon] ": key-lock icon, when this icon appears, it means that the key operation is disabled.

Note: the key-lock status can be set at any screen view by combination of the given keys. At key-lock status, all key operations are disabled except Power button and combination keys for unlocking operation.

- ✧ " [Network Icon] ": net connection icon, it means the device is connected to the network. If the device is disconnected with network, then the icon will disappear.

If the accessories are connected incorrectly or disconnected with the monitor, message "Probe off" pops up on the screen.

Prompt Info. area:

- ✧ "MAP over-limit": display message for current alarm event, the current alarm event is that the measured MAP value exceeds preset value.
- ✧ "Mute 112": display the status of alarm sound, and the counting down time for alarm sound suspending. [Bell Icon] shows the alarm sound is enabled; [Bell with X Icon] shows the alarm sound is silent temporarily for 120 seconds; [Muted Bell Icon] shows the alarm sound is disabled.

Parameter area:

(1). NIBP area

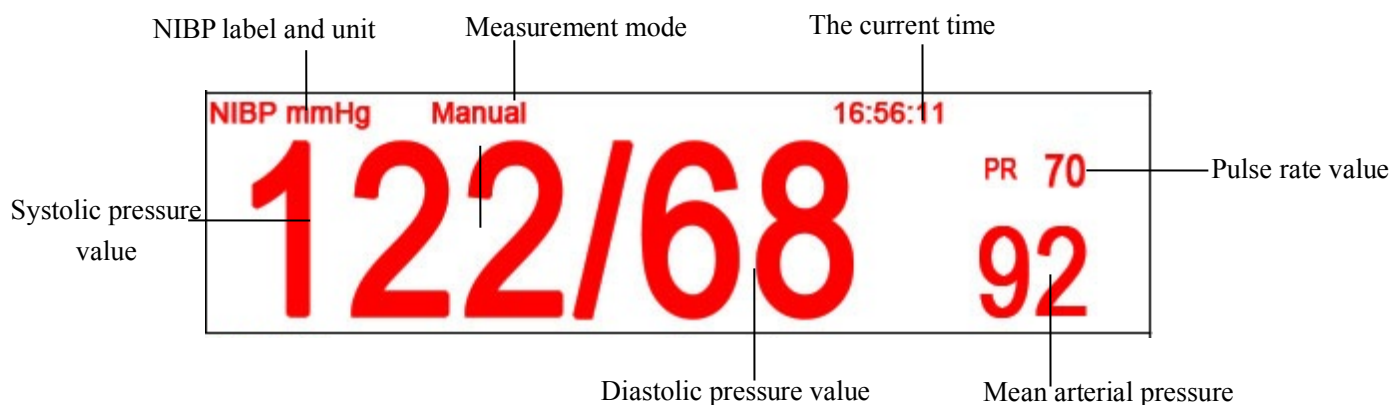

Figure 4.2B NIBP panel

- ✧ "NIBP":the label of blood pressure. "122" is the systolic pressure value, "68" is the diastolic pressure value, and "92" is the mean arterial pressure.
- ✧ "mmHg": the unit of blood pressure value, 1kPa = 7.5mmHg.
- ✧ "PR 70": pulse rate value when taking blood pressure measurement.
- ✧ "Manual": the icon of NIBP measurement mode. There are 3 modes: "Manual" , "Auto" and "STAT". When in "AUTO" mode, a count-down timer is displayed as well.

(2). Heart rate area

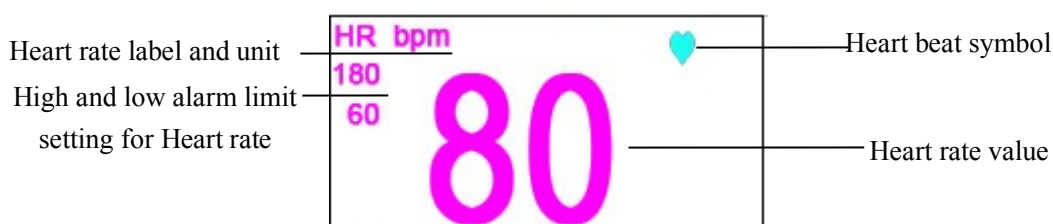

Figure 4.2C Heart rate panel

- ✧ "HR": heart rate. The 80 on the left is the heart rate measured.
- ✧ "bpm": the unit of heart rate, it means "beats per minute".
- ✧ "♥": the heart-beat symbol, blinks corresponding to the R wave of ECG waveform.
- ✧ "180/60": high and low alarm limit setting for heart rate.

(3). Temperature area



Figure 4.2D Temperature panel

(4). SpO₂ area

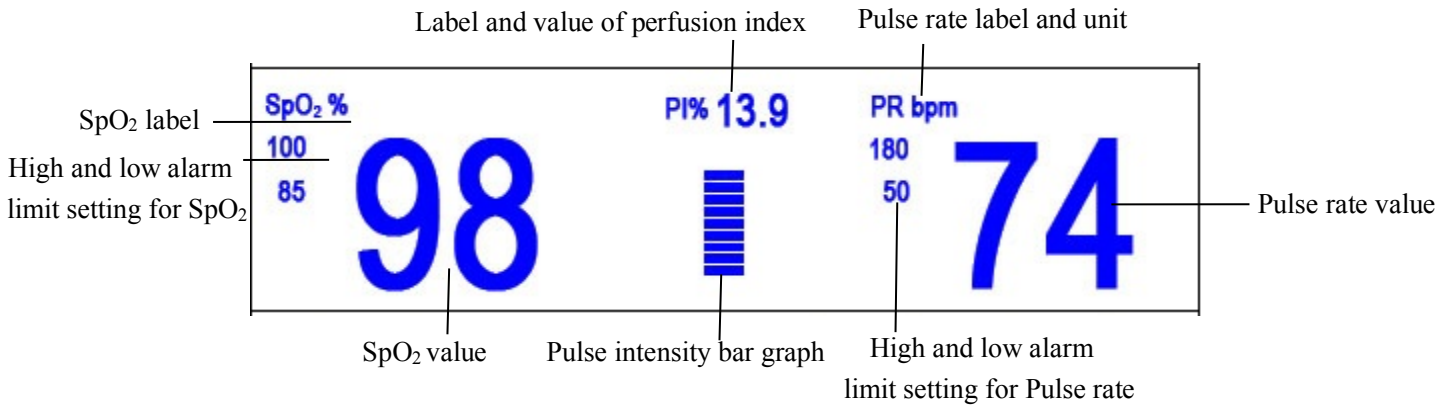

Figure 4.2E SpO₂ panel

Waveform area:

(1). ECG waveform

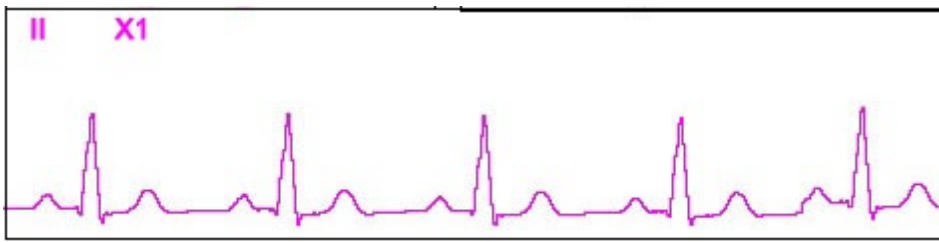

Figure 4.2F ECG waveform

- ◇ "II": lead type. II means ECG lead II.
- ◇ "X1": ECG waveform gain. "X1" means the waveform scale with base gain.

(2). Plethysmogram



Figure 4.2G Plethysmogram

Data display area:

The recent groups of data will be displayed on the lower of the screen, the form is as shown in figure 4.2H.

Time	SYS/DIA/MAP/PR	HR	SpO ₂	PR	Temp
08:24	124 / 70 / 94 / 72	82	97	72	37.2
16:56	122 / 68 / 92 / 70	80	98	74	37.1







Figure 4.2H Data display area

- ◇ "Time": the measuring time.
- ◇ "SYS/DIA/MAP": systolic/diastolic/arterial mean pressure.
- ◇ "HR": the heart rate.
- ◇ "SpO₂": oxygen saturation (SpO₂ for short).
- ◇ "PR": the measured pulse rate from blood pressure measuring channel or pulse rate value from oximetry measuring channel. The PR value from oximetry will be taken priority to be displayed.
- ◇ "TEMP": the temperature value. This function is optional.

Note: 1. If the device is re-started, the data in recent list data area will be cleared.





2. Invalid value will be display as "--"

Key Operation instruction:

- Short pressing display view "  " key to shift screen views.
 - Long pressing display view "  " key to enter into Menu setup screen.
 - For monitor without ECG function, hold Auxiliary key "  " firstly, then press NIBP setup key "  ", by doing this it can lock / unlock key operation. For monitor with ECG function, hold ECG lead key "  " firstly, then press NIBP setup key "  ", by doing this it can lock / unlock key operation
- Note: This function is available in any screen view, we will not cover it again in the following.

- Short pressing print key "  " to activate printing with the format specified by "Setup Menu→System→Print" if the printer is installed.

The following operation is also for the monitor with ECG function.

- Pressing OK "  " key to freeze / unfreeze ECG waveform.
- Short pressing Lead "  " key to shift the ECG lead.
- Short pressing Up/Down("  " / "  ") key to change ECG waveform gain.

Note: there are 7 screen views (depending on your configuration): default screen, screen for real-time ECG waveform only, NIBP list screen, SpO₂ data list screen, alarm event list screen, screen for graphic trend and ECG waveform recall. The following sections will describe each one of these 7 screens.

4.3 Screen for Real-time ECG waveform (Optional)

Note: this screen is only for the monitor with ECG function.

Real-time ECG waveform screen is as shown in figure 4.3.







Figure 4.3 Real-time ECG waveform screen

- ◇ "II": ECG lead.
- ◇ "X2": ECG waveform gain.

Operating instructions:

- Pressing OK "  " key to freeze / unfreeze ECG waveform.

- Short pressing Lead "  " key to shift the ECG lead.
- Short pressing Up/Down("  " / "  ") key to change ECG waveform gain.
- Short pressing Print "  " key to start / stop printing real-time ECG waveform.

4.4 Screen Display for ECG Waveform Recall (Optional)

Note: this screen is only for the monitor with ECG function.

ECG waveform recall screen is as shown in figure 4.4.

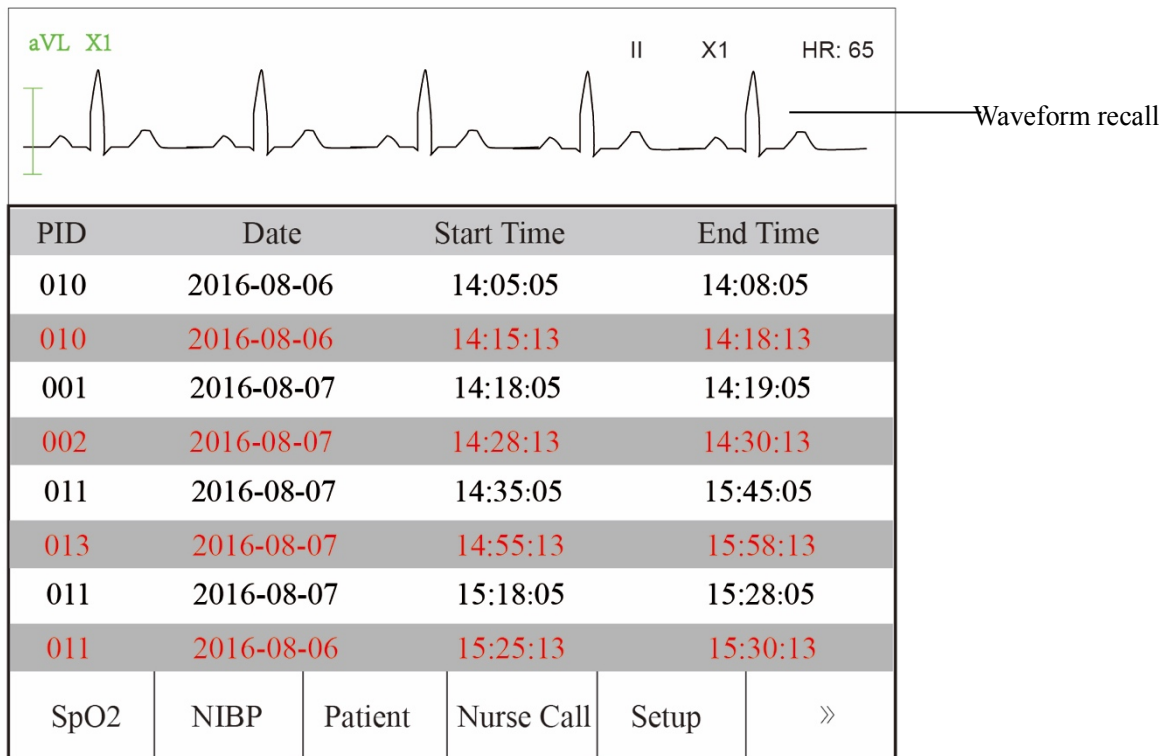

Figure 4.4 Waveform recall screen

ECG waveform displaying area:



1. "II": ECG lead.
2. "X1": waveform gain.
3. "HR 72": heart rate mark and the measured heart rate.

ECG records list area:

- ✧ "PID": the patient ID number.
- ✧ "Date": the date of ECG measurement record.
- ✧ "Start Time": the start time of ECG measurement record.
- ✧ "End Time": the end time of ECG measurement record.

Note: one single ECG record starts from the valid ECG signal (when message "Lead off" disappears) and finishes when ECG lead is off. One single ECG record is not longer than 1 hour.

Operating instructions:

- Press Up "  " key or Down "  " key to select one ECG record, then press OK key to recall the

selected ECG waveform. Press "▲" key or "▼" key to scroll the ECG waveform forward / backward.

- Press print "🖨️" key to print the selected ECG waveform record.
- Long pressing OK "👉" key, then a dialog of deleting records pops up, as shown in figure 4.5, the user can delete all history ECG waveform data according to prompt.

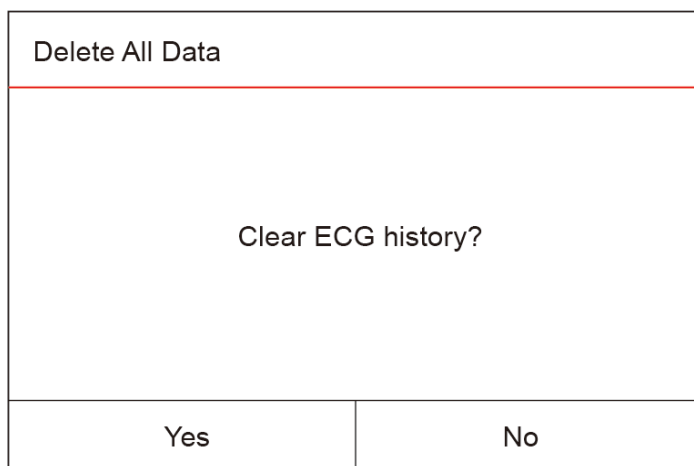

Figure 4.5 Delete ECG history

4.5 NIBP List Screen (Optional)

Note: the screen below is only for the monitor with NIBP function.

NIBP List screen is as shown in Figure 4.6.



PID	Date/Time	SYS/DIA/MAP	PR		
010	2016-08-06 14:05	120 / 81 / 93	71		
010	2016-08-06 14:15	124 / 81 / 93	72		
001	2016-08-06 14:18	124 / 82 / 92	73		
002	2016-08-06 14:08	129 / 83 / 91	74		
011	2016-08-06 14:15	125 / 83 / 94	75		
013	2016-08-06 14:15	126 / 84 / 95	66		
011	2016-08-06 14:18	126 / 85 / 95	70		
011	2016-08-06 14:25	125 / 86 / 96	67		
SpO2	NIBP	Patient	Nurse Call	Setup	»

Figure 4.6 NIBP List

In this screen, the first column is the patient ID, the second column is NIBP recording time, the third column is NIBP value, and the fourth column is pulse rate (measured by NIBP module).

Operating instruction:

- Short pressing Up "▲" key or Down "▼" key to turn to previous or next page for view other NIBP records.

- Short pressing print " " key to print the current NIBP list.
- Long pressing OK " " key, then a dialog of deleting records pops up, the user can delete all NIBP data records according to prompt.

4.6 SpO₂ Data List Screen (Optional)

Note: the screen below is only for the monitor with SpO₂ function.





SpO₂ data list screen is as shown in Figure 4.7.

PID	Date/Time	SpO ₂	PR		
010	2016-08-06 14:05:05	97	71		
010	2016-08-06 14:15:13	98	72		
001	2016-08-06 14:18:05	98	73		
002	2016-08-06 14:08:13	97	74		
011	2016-08-06 14:15:05	96	75		
013	2016-08-06 14:15:13	98	66		
011	2016-08-06 14:18:05	98	70		
011	2016-08-06 14:25:13	97	72		
SpO ₂	NIBP	Patient	Nurse Call	Setup	»

Figure 4.7 SpO₂ data list screen

In this screen, the first column is the patient ID, the second column is SpO₂ recording time, the third column is SpO₂ value, and the fourth column is pulse rate (measured by SpO₂ module).

Operating instruction:

- Short pressing Up " " key or Down " " key to turn to previous or next page for view other SpO₂ records.
- Short pressing print " " key to print the current SpO₂ list.
 - Long pressing OK " " key, then a dialog of deleting records pops up, the user can delete all SpO₂ data records according to prompt.

4.7 Alarm Event List Screen

Alarm Event List screen is as shown in Figure 4.8.

Date/Time	Event	Value	Hi/Lo
08-06 14:05:05	SYS over limit	99	90/60
08-06 14:15:13	SYS over limit	99	
08-06 14:18:05	SYS over limit	99	90/60
08-06 14:08:13	SYS over limit	99	
08-06 14:15:05	SYS over limit	99	90/60
08-06 14:15:13	NIBP signal weak	--	--
08-06 14:18:05	NIBP signal weak	--	--
08-06 14:25:13	SYS over limit	99	99/60

SpO2	NIBP	Patient	Nurse Call	Setup	»
------	------	---------	------------	-------	---

Figure 4.8 Alarm event list

In this screen, the first column is the time the alarm occurs (format is month-day hour:minute), the second column is the event description, the third column is the onset value, and the fourth column is the high/low limit value.

- Short pressing "▲" key or "▼" key to turn to previous/next page for view other alarm events. Note: if the event description is too long to be shown, pressing OK key can show the full description, but the third and fourth column will not be displayed.
- Short pressing print "🖨️" key to print the event list of the current page.
- Long pressing "🗑️" key to enter the screen of clearing recorded alarm events, the user can delete all alarm events according to prompt.

4.8 Trend Graph Display (for HR Option)

Trend graph display screen is as shown in Figure 4.9.

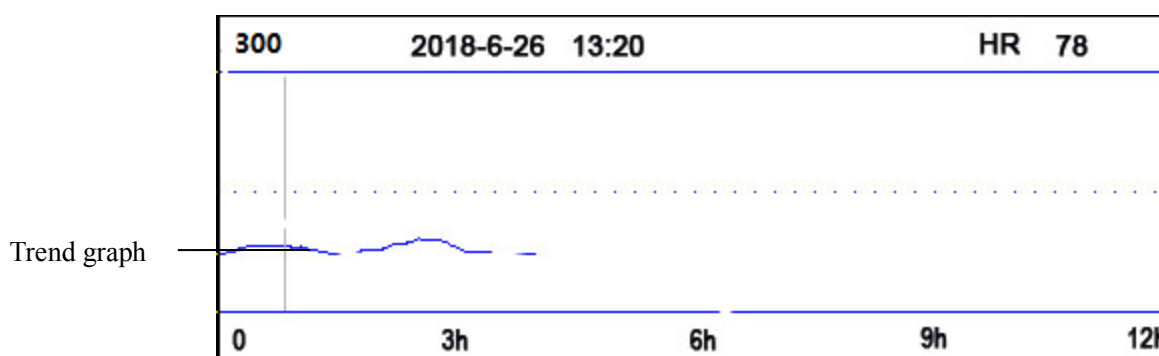





Figure 4.9 Trend Graph screen









Screen description

- ✧ "HR": HR trend graph. If the monitor has ECG function, then "SpO₂" and "HR" can be optional.

Instructions for viewing the trend graph:

- Select "cursor on" and press OK "🗑️" key to confirm, and "cursor on" becomes "cursor off", then you

can press up “” key or down “” key to move the vertical cursor, the list box below will display SpO₂/HR value and the time value at the point where the cursor stays. Move cursor back and forth this way, you can view the SpO₂/HR trend (12/24/96 hours long). Press “” key again to exit trend viewing.

- When pressing “” key or “” key to move cursor, the moving step is variable. The rule is that the initial step is 1 point, after pressing “” or “” key towards the same direction for 5 times, the step becomes 5 points, and with 5 more pressing the step becomes 10, then 20. No matter what step is, as long as you press “” or “” key towards the other direction, the step becomes 1 and towards the other direction.
- Long pressing “” key to enter the screen of clearing all graphic trend records, the user can delete all trend data according to prompt.
- Short pressing print “” key to print this trend graph.

4.9 Setup Menu Screen

Long pressing Display View “” key to enter into the Setup Menu screen, as shown in Figure 4.10.

Note: your monitor may not cover all the functional parameter settings listed in the main menu screen. Please refer to the monitor you purchased.

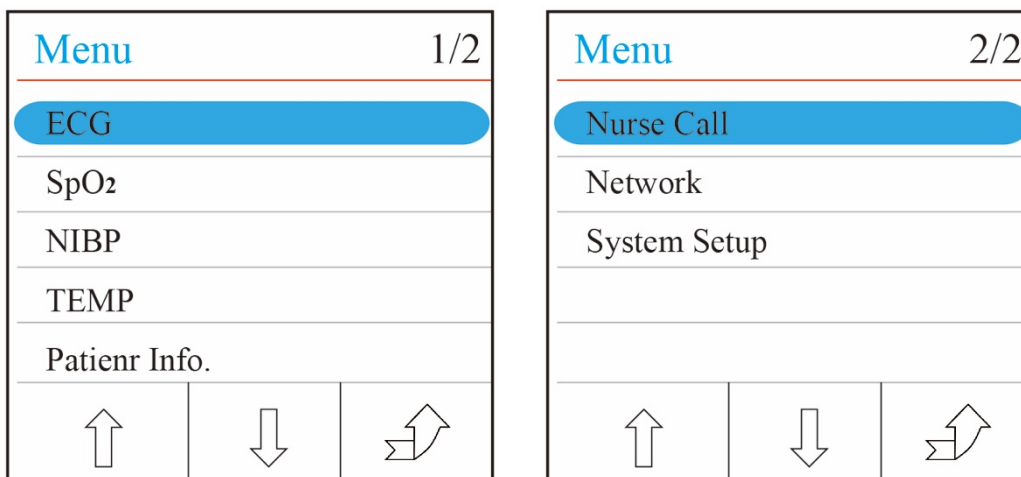







Figure 4.10 Root setup menu screen (refer to your monitor)

There are functional groups for setting parameters: “ECG, SpO₂, NIBP, TEMP, Patient Info, Nurse Call, Network and System setup” on the Setup Menu Screen. NOTE: your monitor may not cover all above functions, such as ECG, TEMP etc. please refer to the monitor in your hand.

Instruction description:◆ **Key operation:**



1. Short pressing “” key or “” key to shift cursor to corresponding functional group setting.
2. Short pressing “” key to confirm and enter into corresponding functional parameter setup screen.
3. Short pressing “” key to exit from Setup Menu Screen.

◆ **Touchscreen operation:**

1. Pressing the corresponding parameter button on the lower screen to directly enter into corresponding functional parameter setup screen.
2. Pressing “” button on the lower screen to exit from Setup Menu Screen.

Note: the device will save the latest setup settings automatically and the most of saved settings are non-volatile, that's to say, when you shut down the device and power up it next time, every setting item shows the settings saved last time except the items like ECG cable setting and NIBP working mode.

4.9.1 ECG Setup (Optional)

ECG		1/2
HR alarm high	180 >	
HR alarm low	40 >	
Unfilter	Off	
Gain	X1 >	
Lead	II >	
		



ECG		2/2
1mV	Off	
Cable	5 >	
Notch	50Hz >	
Pacer	Off	
		

Figure 4.11A ECG setup**Screen description:**







- ◇ "HR alarm high": high alarm limit setting for HR. Setting range: 1~350, the factory default is 180.
- ◇ "HR alarm low": low alarm limit setting for HR. Setting range: 0~349, the factory default is 40.
- ◇ "Unfilter": the switch of filter mode. Select "On" means enhance mode for the filter with extended bandwidth (0.05Hz~40Hz), select "Off" means filter with normal bandwidth (0.5Hz ~ 40Hz).
- ◇ "Gain": set ECG waveform gain, "X1, X2, X4, X1/2, X1/4" for optional.
 - “X1”: Waveform scale with base gain
 - “X2”: Twice scale size of the base gain.
 - “X4”: 4 times scale size of the base gain.
 - “X1/4”: 1/4 size of the base gain
 - “X1/2”: Half scale size of the base gain

- ✧ "Lead": set ECG lead.
- ✧ "1mV": the activation status of the internal 1mV calibration signal. Select "On" means activation of the internal 1mV calibration signal, select "Off" means deactivate it. "On" means the ECG signal source will be the internally generated 1mV signal for calibration, and the calibration signal waveform (1mV, 1Hz square wave) will be displayed on the screen.
- ☞ The 1mV calibration signal is used to test the ECG function of the device. It is not used during normal operation.
- ✧ "Cable": choose the number of lead wires for ECG cable to be used. "3" and "5" for optional. Only lead I, II and III can be selected if "3" lead wires is set. All ECG leads including lead I, II, III, aVR, aVL, aVF, V (V1~V6) can be selected if "5" leads wires is set. The factory default is "3".
- ✧ "Notch": to choose the filter notch. 3 options: OFF, 50Hz, 60Hz. The factory default is 50Hz.
- ✧ "Pacer": Enable the cardiac pacemaker pulse detection, the factory default is "Off". When the "Pacer" is selected (set as "On"), the function of pacemaker pulse detection will be effective. A mark "I" will be overlapped on the ECG waveform. if the pacemaker pulse is detected while the patient wears a cardiac pacemaker.



Note: pacemaker pulse inhibition function is always effective for Heart Rate calculation whether you enable or disable the function of cardiac pacemaker pulse detection or not.

Operation Instructions:

◆ **Key operation:**

1. Press " " key or " " key to move cursor to select parameter. The parameter that the cursor stays will turn to blue, short pressing OK " " key, then the screen shows the parameter value list.
2. Short pressing " " key or " " again to adjust or modify parameter value, and short pressing OK " " key again to confirm and save the setting. Note: long pressing can adjust the parameter swiftly.
3. Short pressing " " key to return to upper level screen.

◆ **Touchscreen operation:**

1. Press the parameter you want to adjust, then the screen shows the parameter value list.
2. Press " " button and " " button to view the parameter value by page, and short tab the value to confirm the setting.
3. Pressing " " button to return to upper level screen.

Note: operation for each parameter setting is similar to ECG setup, so we will not cover it again.

4.9.2 SpO₂ Setup (Optional)

Pressing "SpO₂" button on the lower left of the default screen to enter into SpO₂ setting screen, as shown in figure 4.11.







SpO ₂		1/1
SpO ₂ alarm high	100 >	
SpO ₂ alarm low	90 >	
PR alarm high	190 >	
PR alarm low	40 >	
  		



Figure 4.11B SpO₂ Setup Screen

Screen Description:

- ✧ "SpO₂ alarm high": high alarm limit setting for SpO₂. Setting range: 1%~100%, the factory default is "100".
- ✧ "SpO₂ alarm low": low alarm limit setting for SpO₂. Setting range: 0%~99%, the factory default is "90".
- ✧ "PR alarm high": high alarm limit setting for PR. Setting range: 1%~299%, the factory default is "180".
- ✧ "PR alarm low": low alarm limit setting for PR. Setting range: 0%~298%, the factory default is "40".

4.9.3 NIBP Setup (Optional)

NIBP		1/3
SYS alarm high	180 >	
SYS alarm low	60 >	
DIA alarm high	120 >	
DIA alarm low	50 >	
MAP alarm high	160 >	
  		

NIBP		2/3
MAP alarm low	50 >	
PR alarm high	180 >	
PR alarm low	40 >	
Initial Pressure	150 >	
Unit	mmHg >	
  		

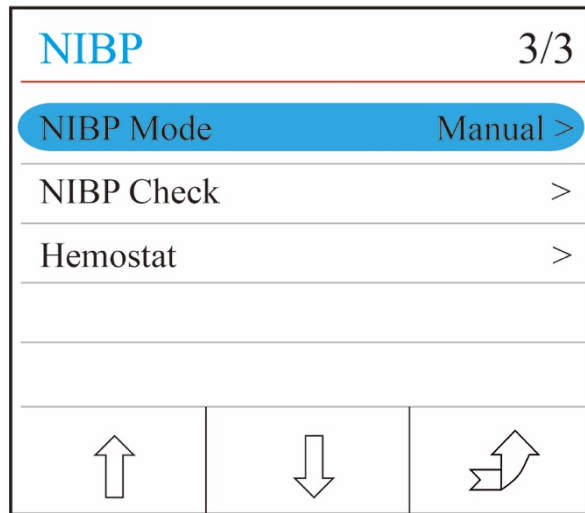

Figure 4.12 NIBP Setup

NIBP Setup Screen Description:

- ✧ **"SYS alarm high"**: high alarm limit setting for systolic pressure.
- ✧ **"SYS alarm low"**: low alarm limit setting for systolic pressure
- ✧ **"DIA alarm high"**: high alarm limit setting for diastolic pressure.
- ✧ **"DIA alarm low"**: low alarm limit setting for diastolic pressure.
- ✧ **"MAP alarm high"**: high alarm limit setting for mean arterial pressure.
- ✧ **"MAP alarm low"**: low alarm limit setting for mean arterial pressure.
- ✧ **"PR alarm high"**: high alarm limit setting for PR. Setting range: 1%~299%, the factory default is "190".
- ✧ **"PR alarm low"**: low alarm limit setting for PR. Setting range: 0%~298%, the factory default is "40".
- ✧ **Initial pressure**: Cuff pressure to be inflated initially, its range is different depending on patient type.

for neonates: initial inflation pressure: setting range: 60~80 mmHg; default value: 70 mmHg.

for pediatrics: initial inflation pressure: setting range: 80~140 mmHg; default value: 120 mmHg.

for adults: initial inflation pressure: setting range: 80~200 mmHg; default value: 150 mmHg.

Note: if the device is configured with "SunTech" blood pressure module, then the initial inflation pressure setting range for adult is 120~200mmHg.

Note: In order to avoid inappropriate initial pressure value which may cause harm to patients, when patient type is changed or measuring mode is altered or patient ID is changed, the inflating pressure value will rollback to the latest setting value.

- ✧ **"Unit"**: the pressure unit. mmHg and kPa for optional.
- ✧ **"NIBP Mode"**: NIBP measuring mode, "STAT", "Manual", "CUSTOM", "AUTO 1", "AUTO 2", "AUTO 3", "AUTO 4", "AUTO 5", "AUTO 10", "AUTO 15", "AUTO 20", "AUTO 30", "AUTO 40", "AUTO 50", "AUTO 60", "AUTO 90", "AUTO 120", "AUTO 240 and "AUTO 480" are optional. When "STAT" is selected, it means the device will do a short-term (5 minutes) automatic NIBP measurement. "AUTO 1" means NIBP measurement takes once every minute automatically; "AUTO 480" means NIBP measurement takes once every 480 minutes automatically; In AUTO mode, the counting-down timer is displayed in MAP (Time) segment on upper right corner.

Note: when "STAT" (short-term automatic NIBP measurement) mode is selected, the MAP value will

change to display label "STAT" prompting the current NIBP mode, therefore the MAP value will not be displayed. When the "STAT" mode (at most lasting 5 minuter) finishes (or measurement error occurs or it is interrupted manually), then the device will shift into "Manual" mode automatically.

- ✧ **"NIBP Check"**: press it to enter into NIBP verification setup screen, as shown in figure 4.13.

Note: password need to input to perform NIBP Check. Default password is "1234".

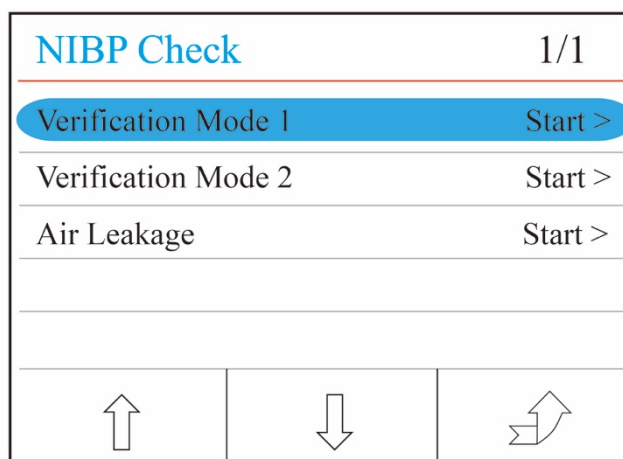

Figure 4.13 NIBP verification setup screen

Screen description:

- ✧ "Verification mode 1": Pressure source is generated by internal pump. Move the cursor to NIBP Verification mode 1 "Start" button, press the OK button to begin the pressure meter verification. (Meanwhile, the "Start" shifts to "Stop", after the verification the "Stop" shifts to "Start").
- ✧ "Verification mode 2": Pressure source is coming from outside. Move the cursor to NIBP Verification mode 2 "Start" button, press the OK key to begin the pressure meter verification. (Meanwhile, the "Start" shifts to "Stop", after the verification the "Stop" shifts to "Start").
- ✧ "Air leakage": Check the air leakage in the pneumatic system. Move the cursor to Air Leakage "Start" button, press the OK key, the pump inflates to certain pressure and then the valve will be closed to detect leakage for 10 seconds, then the pressure will be released automatically and the screen displays the checking result
- ✧ If the following message pops up, then NIBP measurement should be stopped.
 - 1) Pressure verification...
 - 2) Air leakage preparing...
 - 3) Air leakage countdown...
 - 4) Air leakage in 10s:...
- ✧ **"Hemostat"**: press it to enter into Hemostat setup screen, as shown in figure 4.14.

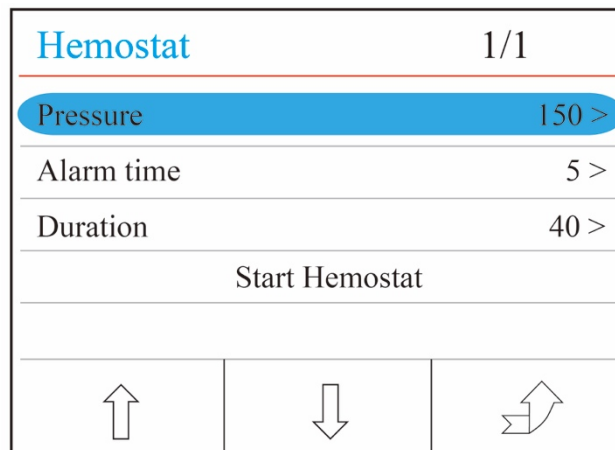

Figure 4.14 Hemostat setup screen

Hemostat Setup Screen Description:

- ✧ “Pressure”: when you use hemostat function, you need to preset a cuff pressure for hemostasis. The pressure is adjustable, and its adjusting limit is different for different patient category:

for neonates: preset range: 70~100 mmHg, default value: “90” mmHg;

for pediatrics: preset range: 80~130 mmHg, default value: “110” mmHg;

for adults: preset range: 80~180mmHg, default value: “140” mmHg.

If the pressure drops down slowly under 10mmHg compared with the preset value due to little air leakage in the pneumatic system when time passes by, the monitor will re-inflate to maintain the cuff pressure close to the preset pressure value.

Note: the unit of cuff pressure is the same with the NIBP unit in NIBP Setup.

- ✧ “Duration”: After presetting the cuff pressure, you need to set the time period for maintaining the preset pressure after inflation. “5, 6, 7,...120” minutes adjustable. The default value is “40” minutes.
If the set value is “xx” minutes, the monitor will count down from “xx” minutes automatically when starting cuff inflation. When time is up, it will deflate automatically.
- ✧ “Alert Time”: the alert time for reminding user that the operation of hemostat is going to be end after this time period. 1 to 60 minutes adjusting range with 1 minute step, the default value is “5” minutes. If the set value is “xx” minutes, the monitor will produce alarm sound until ending deflation when counting down time reaches to “xx” minutes. The alarm type is high priority alarm. (For example: the duration is 40 minutes, the alert time is 5 minutes, the alarm will ring for prompt when the duration counting down to 5 minutes. The Prompt Info area starts to prompt: Hemo C-D 300 seconds.)
- ✧ “Start Hemostat”: move the cursor to “Start Hemostat” and press “” key (or press "Start Hemostat" button on the screen), then “Start Hemostat” becomes “Stop Hemostat” and meanwhile the blood cuff starts being inflated; Pressing “Stop Hemostat” button can stop using this function. After deflation, it will change to “Start Hemostat” again.

Safety instruction:

 The NIBP calibration and Air leakage detection can only be carried on when the NIBP measurement is set to mode “Manual”.

NIBP setup screen description:

Short pressing NIBP setup “” key to enter into NIBP setup screen, as shown in figure 4.15.

In NIBP setup screen, short pressing " " key to select measuring mode. Press NIBP measuring " " key to confirm the setting and exit from setup screen. Short pressing display view " " key to exit. Press up/down key to select patient type.

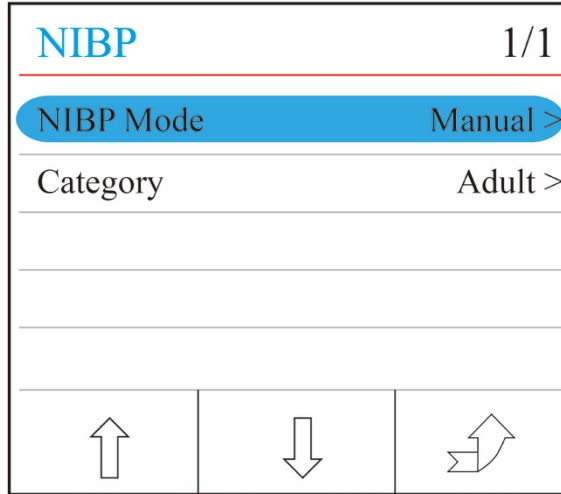

Figure 4.15 NIBP setup screen

4.9.4 TEMP Setup (Optional)

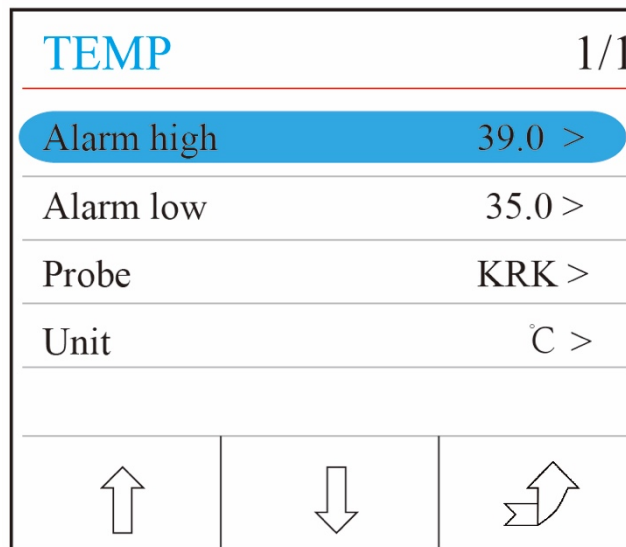

Figure 4.16 TEMP setup screen

Screen description:

- ✧ **“Alarm high”**: high alarm limit setting for temperature. Setting range: 0.1~60.0°C, step is 0.1. The factory default is "39°C".
- ✧ **“Alarm low”**: low alarm limit setting for temperature. Setting range: 0~59.9°C, step is 0.1. The factory default is "35°C".
- ✧ **“Probe”**: to change or set the temperature probe type, “KRK” and “YSI” for optional.
- ✧ **“Unit”**: to change or set the temperature unit, “°C” and “°F” for optional.

4.9.5 Patient Info

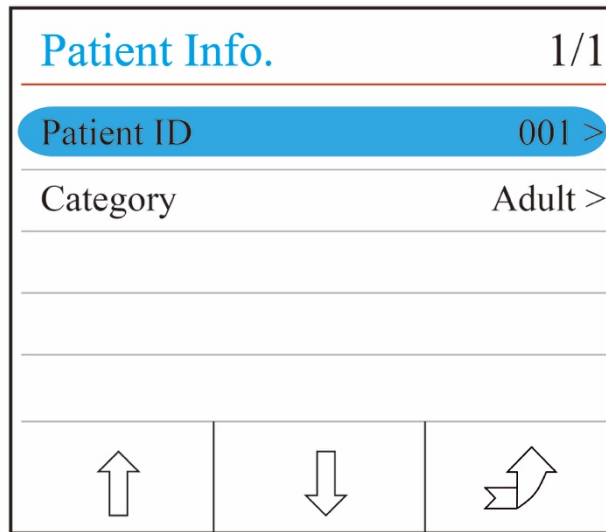

Figure 4.17 Patient Info. setup screen

Screen description:

- ✧ **“Patient ID”**: change or set current patient’s ID number, 0~100 adjustable; Once the patient ID is changed, the history data in trend graph will be cleared, and the parameter settings will be resumed to default value.
- ✧ **“Category”**: change or set the category of current patient; three options “Adult” ,“Pediatric” and “Neonate”, press OK key to confirm the setting and the patient type indicator will be ON at the front panel of the device. The default is “Adult”.

4.9.6 Nurse Call Setup

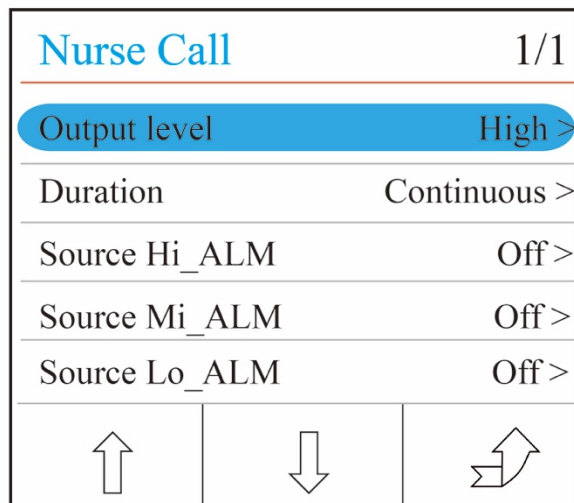
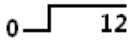
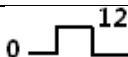
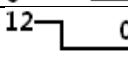
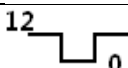

Figure 4.18 Nurse Call Setup Screen

Screen Description:

- ✧ **“Output level”**: two options “Low” or “High” output levels are available.
- ✧ **“Duration”**: two options “Pulse” and “Continuous” output modes are available; Refer to the following form for the Output level and Duration.

Output level	Duration	Output (format)
High	Continuous	0  12
Low	Pulse	0  12
High	Continuous	12  0
Low	Pulse	12  0

- ✧ **“Source Hi_ALM / Source Mi_ALM / Source Lo_ALM”**: three kinds of alarm sources can trig the nurse call: high level alarm, medium level alarm and low level alarm (multi-optional). After selecting the responding alarm level, the device will send out the nurse call signal according to "Source" and "Output level". If you don't select any source, nurse call signal will not be generated (Note: the item "Source" can be multi-selected.)

Note: Nurse Call function can not be regarded as main alarm notice method, please do not entirely rely on it. You should combine parameter values with alarm level and patient's clinical behavior and symptom to determine patient's condition.

4.9.7 Network Setup

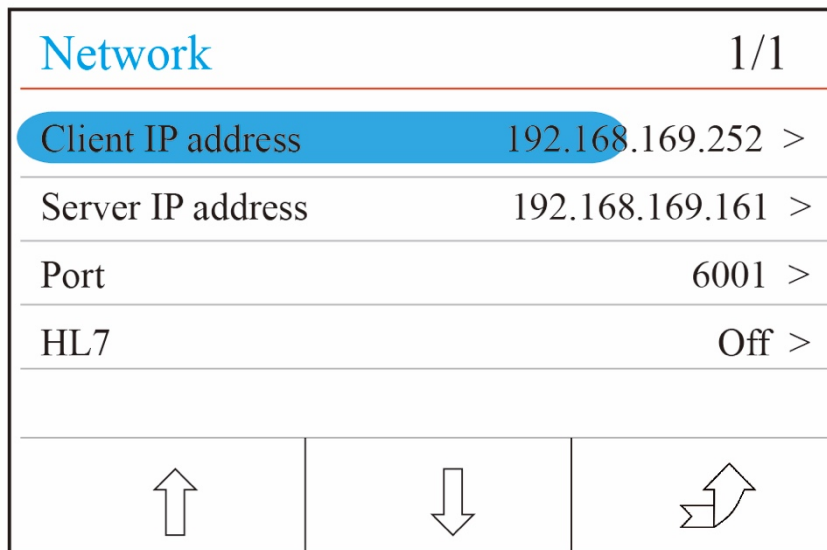



Figure 4.19 Network Setup Screen

- ✧ **“Client IP Address”**: to set the local IP address for this device working as client.
- ✧ **“Server IP Address”**: to set the IP address of remote server (work station) when connecting to a central monitoring system.
- ✧ **“Port”**: the remote port number to which the monitor will connect to the work station in the central monitoring system. Its setting range is from 6001 to 6064. It can also be used to represent the patient bed number connecting to the work station. For example, the port number 6002 means the monitor is assigned to the bed number 2 in the CSM. The work station can connect to up to 64 bedside monitors, so please set the port between 6001 and 6064. Press "  " to make the new setting effective.
- ✧ **“HL7 (Protocol)”**: enable or disable the monitor to export data to CIS/HIS by HL7 protocol. Set it as “On” means enable HL7 protocol. The default is “On”, that's to say, enabled HL7 protocol. When the HL7 protocol is set as “On”, then item **“Server IP Address”** and **“Port”** are nonadjustable.

4.9.8 System Setup

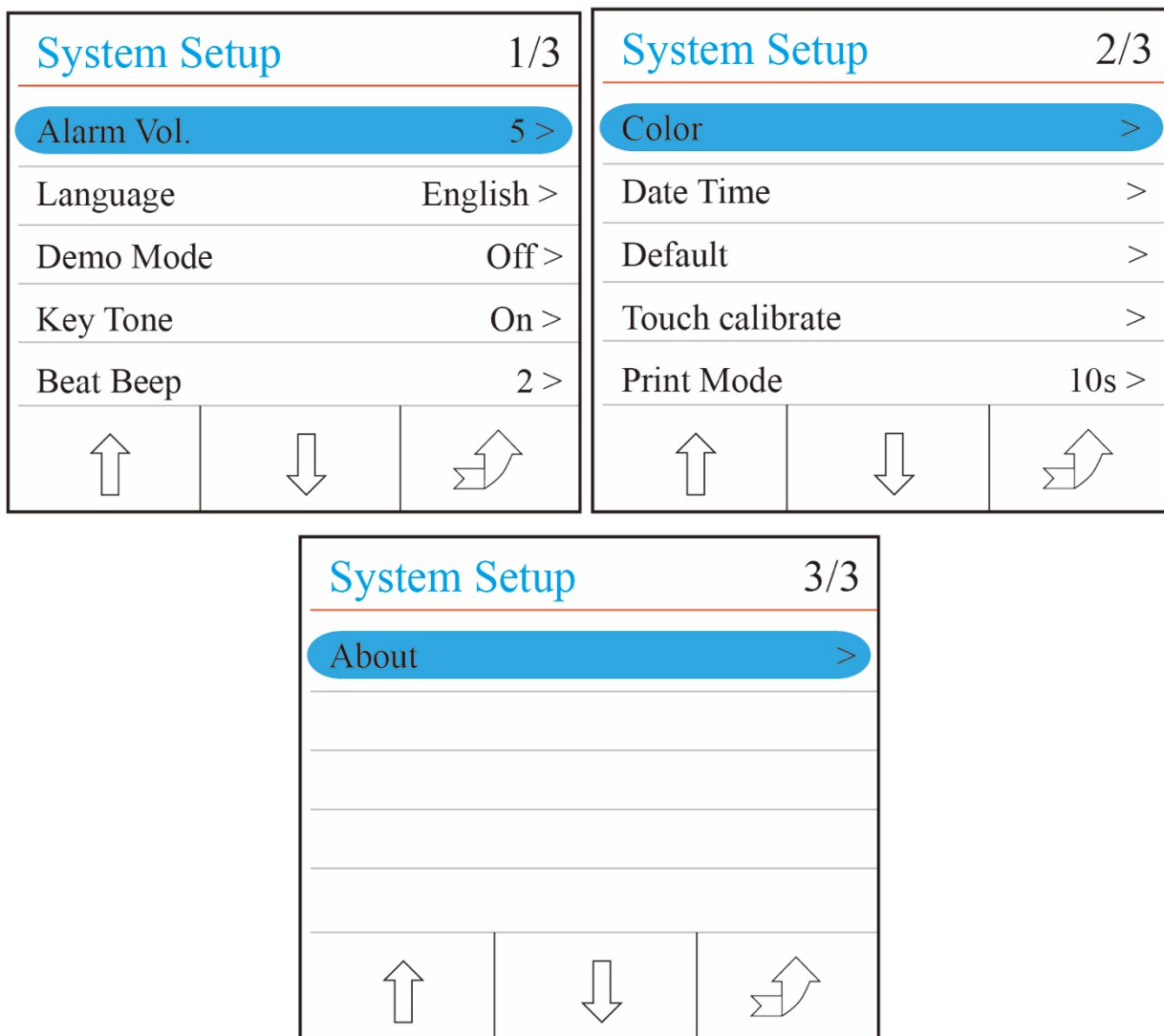

Figure 4.20 System Setup Screen

Screen Description:

- ✧ **“Alarm Vol.”**: set alarm volume, “1~10” level adjustable, the factory default is 05. It is recommended that the alarm volume shouldn’t be adjusted lower than the factory default value unless the nursing personnel keeps close attention and surveillance on the patients and the device at all times.
- ✧ **“Language”**: language selection. “English”, “Simplified Chinese”, “Traditional Chinese”, “German”, “Spanish”, “French”, “Italian”, “Portuguese”, “Polish” and “Turkey” for optional, the factory default is “English”.
- ✧ **“Demo Mode”**: to enter into the demonstration mode. This item needs entering password, the default password is “1234”.
“Demo” shows the demonstration waveform and data, which are generated by the monitor.
- ✧ **“Key tone”**: to turn on/off key tone, the default is “ON”.
- ✧ **“Beat beep”**: adjust the volume of pulse beeping sound. “0~7” level adjustable. “0” means switching off the pulse beep sound, the factory default is “2”. The tone of pulse beat beep changes when the measured SpO₂ changes, that is so called pitch-tone function. The higher the SpO₂ value is, the higher





the tone frequency of pulse beep (sound becomes sharper); The lower the SpO₂ value is, the lower the tone frequency of pulse beep (sound becomes flatter).

- ✧ **"Color"**: to set the displaying color for each parameter (such as for SpO₂ and NIBP). There are "Navy Blue", "Green", "Red", "Light blue" and "Pink" for optional.
- ✧ **"Date/Time"**: to set the system date and time, date format: yyyy-mm-dd; time format: hh-mm.
- ✧ **"Default"**: to reset to default setting, press "Yes" to reset to the default setting, and press "No" to return to upper level screen.
- ✧ **"Touch Calibrate"**: to enter into touchscreen calibration screen. There will is cross cursor "⊕" appears on the screen, tap the cross point "⊕" of the cross cursor with the stylus or finger one by one to finish the calibration. Note: after calibration, the monitor will be auto shutdown and auto restart.
- ✧ **"Print Mode"**: to set the printing time for real-time printing mode with the options of "Continuous", "10s", "20s", "30s" and "60s" for optional. "Continuous" means that the device will not stop printing the real-time plethysmogram and ECG waveform until the user change the display screen or press the print key again.
XXs: prints the real-time plethysmogram and ECG waveform lasting for XX seconds.
- ✧ **"About"**: to enter into system information screen which displays the software version and serial number.

4.10 Alarm Settings

Pressing alarm silence " key to set the alarm sound status.

There are 3 status in total:

- ✧ Alarm sound is enabled, this is the default status..
- ✧ Alarm silence lasts for 120 seconds: short pressing alarm silence key, the red icon " will be displayed on the lower screen, and message "silence count-down time 120". At this time, the alarm silence indicator on the left side of alarm silence key will be light. The device will mute the alarm sound temporarily for 2 minutes, but keep the visual alarm (lamp) flashing. When the counting down time (120s) is out, the alarm silence will be de-activated automatically, the red icon " will disappear as well, and the alarm silence indicator will be dark.
- ✧ Alarm silence lasts all the time: long pressing alarm silence key, the red icon " will be displayed on the lower column of the screen. At this time, the alarm silence indicator on the left side of alarm silence key will be light. The device will mute the alarm sound in the future, but keep the visual alarm (lamp) flashing. Till a new type of alarm event is detected, the alarm silence status will be terminated automatically and the alarm sound will resume, the red icon " will disappear as well, and the alarm silence indicator will be dark.

Note: If the current status is alarm silence, longtime or short time pressing the alarm silence key can de-activate the alarm silence function.

Chapter 5 Alarm

5.1 Alarm Priority

Low Priority:

NIBP over range
 Temp over range
 ECG Lead off
 SpO₂ Probe off
 Temp Probe off
 NIBP error message
 SpO₂ error message

Medium Priority:

HR/PR over range

High Priority:

ECG Arrest
 Ventricular Run
 Ventricular fibrillation
 SpO₂ over limit
 SYS over limit
 DIA over limit
 MAP over limit
 Temp over limit
 HR/PR over limit
 Can not detect SpO₂
 Can not detect HR/PR

5.2 Alarm Signal Generation

When there is alarm condition, the monitor generates alarm signal with visual indications (which are shown by two ways: LED indicator with different color and textual message display) and audible indication.

Visual Alarm Indication

The flashing rates for the three categories of alarms are shown in the table below.

LED Indicator Color	Alarm Category	Flashing Rate
Red flashing	High priority alarm	2 Hz
Yellow flashing	Medium priority alarm	0.5 Hz
Yellow light	Low priority alarm	Constant(on)(non-flashing)

Table 5.1

Refer to Chapter 11 Alarm Information for detailed alarm message descriptions.

Audible Alarm Indication

The audible alarm has different tone pitch and on-off beep patterns for each priority category. These are summarized in the table below.

Alarm Category	Tone Pitch	Beep Chain
High priority alarm	~400Hz	10 beeps pause 3 sec.
Medium priority alarm	~500Hz	3 beeps pause 5 sec.
Low priority alarm	~500Hz	Single beep

Table 5.2

Note: Visual alarm indication can not be suspended or removed. Audible alarms may be decreased in volume or silenced as described.

5.3 Alarm Reset and Silence

Press  (Alarm Silence) key to pause the audible alarm temporarily or reset the current alarm condition. During the monitoring process, press "Alarm Silence" key shortly to start the alarm silence for 2 minutes. The counting down time shows up on the upper left corner of the screen once the alarm silence is activated. Long pressing "Alarm Silence" key will reset the current alarm condition, that means the sound mute for this alarm will not resume unless another alarm condition occurs. During the alarm silence period, if there is a new alarm condition other than the current one occurs, the device will generate the audible alarm indication again automatically. After the end of alarm silence period, if the current alarm condition still exists, then the audible alarm indication will resume as well.

When the monitor generates alarms, the user can press  key to reset or pause the audible alarm indication for a given silence period when necessary..

- **DO NOT silence the audible alarm or decrease its volume if patient safety could be compromised.**
- For the alarm conditions of "Can not detect SpO₂" and "Can not detect HR/PR", the audible alarm indication will only last for about 7 seconds.
- Alarm signal can be reset, but it can NOT be deactivated all the time.





5.4 Alarm Settings

- 1、 Except volume of audible alarm can be adjustable, the other properties of the alarm signal cannot be adjusted by the user, such as alarm priority setting, alarm light flashing and so on. In addition, all alarms in this patient monitor are "non-latched" type, that is to say, when the alarm condition does not exist, the corresponding alarm signal will automatically stop.

The alarm volume range is shown as below:

- ◇ High: 45dB~80dB (The distance from the front of device to the test instrument is 1m)
 - ◇ Medium: 45dB~75dB (The distance from the front of device to the test instrument is 1m)
 - ◇ Low: 45dB~70dB (The distance from the front of device to the test instrument is 1m)
- 2、 When the icon  displays on the screen and its color is red, that means the alarm volume is 0 (alarm is mute), at this time the user should pay more attention to the patient.
 - 3、 If occurrence of multiple alarm signal at the same time, the monitor will only show the high priority alarm in the form of auditory alarm and light alarm. Meanwhile, all alarm signals information including



message descriptions and numerical flash and so on will be shown respectively and simultaneously on the screen.

-  It is suggested that the users should not change the alarm volume lower than the factory default setting if close and constant attention could not be paid to the patient, otherwise the negligence of alarm event might cause irreversible harm to the patient.
 -  During the alarm silence period, any new alarm event can activate the audible alarm again and the audible alarm function resumes normal state.
 -  After the alarm silence time counts down to 0, or the operator presses the Alarm Silence Key again, then the system will resume to the audible alarm signal if this alarm condition still exists.
 -  The alarm limit value should NOT be set to exceed the declared measuring or display range, or the system alarm signal will not be generated.
 -  The alarm system will still maintain the settings before it is switched off, when the device is turned on again after turning off the power (including the external power supply and the internal power supply).
- 4、 Alarm settings are non-volatile, that means the previous settings will still sustain if the patient monitor is powered off (by accidental power interrupt or by normal power down) and reboot.
 - 5、 When pressing the Alarm Silence Key, the system will stay on "Alarm Silence" status and this status will last for 2 minutes.
 - 6、 It takes only 1 second from canceling alarm silence to resuming alarm sound .

Long press of Display View " " key to enter into the Setup Menu screen, and move the cursor to each parameter (such as SpO₂, NIBP...) to make the high/low limit setting.

 Limits setup: Move to the High or Low limits of the alarm settings, and press the "Alarm" silence key to turn ON or OFF the alarm for the setting. The alarm silence indicator will reflect this with a yellow light showing that alarms are silenced.

Refer to Chapter 11.2 for detailed default alarming values of all parameters and setup range.

-  **Whenever the monitor is used, check the alarm limits to ensure that they are appropriate for the patient being monitored.**
-  **When mains power supply is lost for not more than 30s, the alarm settings prior to the power interrupt will sustain or be restored automatically.**

5.5 Verifying Alarm Function

To verify the effectiveness of the alarm function, set the monitor working at "Demo" mode in system parameter settings menu. Adjust the alarm limits or change alarm setting, then pay a close attention to the alarm signal. If the visual and audible alarm indications appear according to your setting, it means the alarm function is effective. Do NOT set the alarm volume lower than the background noise.

Chapter 6 Technical Specifications

6.1 NIBP Monitoring

1. Measuring method: Oscillometric Technique
2. Pneumatic pressure measuring range: 0 mmHg~300mmHg
3. Accuracy of pressure measurement: ± 3 mmHg
4. Cuff inflation time: <10 seconds (typical adult cuff)
5. Measurement time on the average: < 90 seconds
6. Air release time while the measurement is canceled: ≤ 2 seconds (typical adult cuff)
7. Initial cuff inflation pressure
Adult: 175 mmHg Pediatric: 135 mmHg Neonate: 65 mmHg
8. Overpressure protection limit
Adult: ≤ 300 mmHg Pediatric: ≤ 240 mmHg Neonate: ≤ 150 mmHg
9. NIBP measurement range:

press (unit)		Adult	Pediatric	Neonate
SYS	mmHg	40~275	40~200	40~135
MAP	mmHg	20~230	20~165	20~110
DIA	mmHg	10~210	10~150	10~95

10. NIBP measurement accuracy:
Maximal mean difference: ± 5 mmHg
Maximal standard deviation: 8 mmHg
Measurement mode: Manual, Auto, STAT

6.2 SpO₂ Monitoring

1. Transducer: dual-wavelength LED
Wavelength: Red light: 660 nm, Infrared light: 905 nm.
Maximal optical output power: less than 2mW maximum average
2. SpO₂ measuring range: 35%~100%
3. SpO₂ measuring accuracy: Arms* is not greater than 2% for SpO₂ range from 70% to 100%
*NOTE: Accuracy defined as root-mean-square value of deviation according to ISO 80601-2-61.
4. Low perfusion performance: the declared accuracy is attained when the pulse amplitude modulation ratio is as low as 0.4%.

6.3 Pulse Rate monitoring

1. Pulse rate measuring range: 30bpm~240bpm
 2. Pulse rate measuring accuracy: ± 2 bpm or $\pm 2\%$, whichever is greater.
- Note: The pulse rate ACCURACY is tested by an electronic pulse simulator.

6.4 TEMP Monitoring

1. TEMP measuring range: 21.0°C~50.0°C
2. TEMP measuring accuracy: not greater than 0.2 °C for TEMP measuring range from 25.0°C~45.0 °C

- TEMP responding time: $\leq 150s$ for KRK sensor; $\leq 40s$ for YSI sensor

6.5 Data Recording

- Sensitivity selection tolerance: $\pm 5\%$
- Recording speed: 25mm/s
- Recording speed accuracy: $\pm 10\%$
- Hysteresis: $\leq 0.5mm$
- Frequency response: 0.5~40Hz for normal mode, 0.05~40Hz for enhanced mode.
- Time constant: $\geq 0.3s$ for normal mode, $\geq 3.2s$ for enhanced mode.

6.6 Other Technical Specifications

- AC power supply voltage: 100~240VAC
- AC power frequency: 50/60 Hz
- Battery specification: 11.1V/4400mAh (Li-ion Battery)

6.7 Operating Environment

Working Environment

- Ambient temperature range: 5°C ~ 40°C
- Relative humidity: 30 ~ 80%
- Atmospheric pressure: 70kPa ~ 106kPa

Transport and Storage Environment

- Ambient temperature range: -20°C ~ 60°C
- Relative humidity: 10 ~ 95%
- Atmospheric pressure: 50.0kPa ~ 107.4kPa

6.8 Classification

Safety standard	IEC 60601-1
The type of protection against electric shock	Class I equipment.
The degree of protection against electric shock	Type BF, CF applied parts
Electro-Magnetic Compatibility	Group I, Class A

6.9 ECG Monitoring

- Input signals range in amplitude: $\pm (0.5 \text{ mVp} \sim 5 \text{ mVp})$
- Heart rate display range: 15 bpm ~ 350 bpm
- Heart rate display accuracy: $\pm 1\%$ or $\pm 2 \text{ bpm}$, whichever is greater.
- Heart rate averaging: Averages the recent eight beats having RR intervals falling within the acceptable limits.
- Defibrillation recovery time: $\leq 10 \text{ sec}$
- Alarm signal (for any alarm source) generation delay time: $< 1 \text{ sec}$

Heart rate alarm condition delay time: ≤ 10 sec

7. Response time to change in heart rate:

Change from 80 bpm to 120 bpm: < 8 sec

Change from 80 bpm to 40 bpm: < 8 sec

8. Tall T-wave rejection: Rejects all T-wave less than or equal to 120% of 1mV QRS.

9. Sensitivity selection:

$\times 1/4$, 2.5mm/mV tolerance: $\pm 5\%$

$\times 1/2$, 5mm/mV tolerance: $\pm 5\%$

$\times 1$, 10mm/mV tolerance: $\pm 5\%$

$\times 2$, 20mm/mV tolerance: $\pm 5\%$

10. Sweeping speed: 25mm/s tolerance: $\pm 10\%$

11. ECG noise level: $\leq 30\mu\text{V}_{\text{p-p}}$.

12. ECG input loop current: $\leq 0.1\mu\text{A}$

13. Differential input impedance: $\geq 10\text{M}\Omega$

14. Common-mode rejection ratio (CMRR): $\geq 105\text{dB}$

15. Time constant: $\geq 3.2\text{s}$ for enhance mode, $\geq 0.3\text{s}$ for normal mode.

16. Frequency response: 0.05Hz~40 Hz for enhance (unfilter) mode, 0.5Hz~40Hz for normal mode.

Additional declarations to conform the particular standard of IEC 60601-2-27 “Medical electrical equipment – Part 2-27: Particular requirements for the safety, including essential performance, of electrocardiographic monitoring equipment”

Direct current for respiration, leads-off sensing, and active noise suppression	Applied current less than 0.1 microamperes.	
Response to irregular rhythm	A1 Ventricular bigeminy-80BPM A2 Slow alternating ventricular bigeminy-60BPM A3 Rapid alternating ventricular bigeminy-120BPM A4 Bidirectional systoles-90BPM	
Time to ALARM for tachycardia	<u>Waveform B1, Amplitude</u>	<u>Average Time to Alarm</u>
	0.5 mV 1 mV 2mV	<8 sec <8 sec <8 sec
	<u>Waveform B2, Amplitude</u>	<u>Average Time to Alarm</u>
	1mV 2mV 4mV	<8 sec <8 sec <8 sec

6.10 Guidance and manufacturer's declaration-Electromagnetic compatibility

Table 1

**Guidance and manufacturer's declaration-electromagnetic emission
for all EQUIPMENT AND SYSTEM**

Vital Signs Monitor is intended for use in the electromagnetic environment specified below. The customer or the user of the equipment or system should assure that it is used in such an environment.		
Emissions test	Compliance	Electromagnetic environment-guidance
RF emissions CISPR 11	Group 1	Vital Signs Monitor uses RF energy only for its internal function. Therefore, its RF emissions are very low and are not likely to cause any interference in nearby electronic equipment.
RF emissions CISPR 11	Class A	Vital Signs Monitor is suitable for use in all establishments other than domestic and those directly connected to the public low-voltage power supply network that supplies buildings used for domestic purposes.
Harmonic emissions IEC61000-3-2	Class A	
Voltage fluctuations/flicker emissions IEC61000-3-3	Complies	

Table 2

**Guidance and manufacturer's declaration-electromagnetic immunity
for all EQUIPMENT AND SYSTEMS**

Vital Signs Monitor is intended for use in the electromagnetic environment specified below. The customer or the user of the equipment or system should assure that it is used in such an environment.			
Immunity test	IEC60601 test level	Compliance level	Electromagnetic environment -guidance
Electrostatic discharge(ESD) IEC61000-4-2	±8 kV contact ±15 kV air	±8 kV contact ±15kV air	Floors should be wood, concrete or ceramic tile. if floors are covered with synthetic material, the relative humidity should be at least 30%
Electrical fast transient/burst IEC61000-4-4	±2kV for power Supply lines ±1 kV for input/output lines	±2kV for power Supply lines ±1 kV for input/output lines	Mains power quality should be that of a typical commercial or hospital environment.
Surge IEC 61000-4-5	±1kV line (s) to line(s) ±2kV line(s) to earth	±1kV differential mode ±2kV common mode	Mains power quality should be that of a typical commercial or hospital environment.
Voltage dips, short interruptions and voltage variations on power supply input lines IEC61000-4-11	<5 % U_T (>95 % dip in U_T) for 0,5 cycle 40 % U_T (60 % dip in U_T) for 5 cycles 70 % U_T (30 % dip in U_T) for 25 cycles <5 % U_T (>95 % dip in U_T) for 5 s	<5 % U_T (>95 % dip in U_T) for 0,5 cycle 40 % U_T (60 % dip in U_T) for 5 cycles 70 % U_T (30 % dip in U_T) for 25 cycles <5 % U_T (>95 % dip in U_T) for 5 s	Mains power quality should be that of a typical commercial or hospital environment. If the user of the equipment or system requires continued operation during power mains interruptions, it is recommended that the equipment or system be powered from an uninterruptible power supply or a battery.
Power frequency (50Hz/60Hz) magnetic field IEC61000-4-8	3A/m	3A/m	Power frequency magnetic fields should be at levels characteristic of a typical location in a typical commercial or hospital environment.
NOTE U_T is the a.c. mains voltage prior to application of the test level.			

Table 3

**Guidance and manufacturer's declaration – electromagnetic immunity-for
EQUIPMENT and SYSTEM that are not LIFE-SUPPORTING**

Vital Signs Monitor is intended for use in the electromagnetic environment specified below. The customer or the user of Vital Signs Monitor should assure that it is used in such an electromagnetic environment.

IMMUNITY test	IEC 60601 test level	Compliance level	Electromagnetic environment - guidance
Conducted RF IEC 61000-4-6	3 Vrms 150 kHz to 80 MHz	3V	<p>Portable and mobile RF communications equipment should be used no closer to any part of Vital Signs Monitor, including cables, than the recommended separation distance calculated from the equation applicable to the frequency of the transmitter.</p> <p>Recommended separation distance</p> $d = 1.2 \sqrt{P}$ $d = 1.2 \sqrt{P} \quad 80 \text{ MHz to } 800 \text{ MHz}$ $d = 2.3 \sqrt{P} \quad 800 \text{ MHz to } 2,5 \text{ GHz}$
Radiated RF IEC 61000-4-3	3 V/m 80 MHz to 2.5 GHz	3 V/m	<p>Where P is the maximum output power rating of the transmitter in watts (W) according to the transmitter manufacturer and d is the recommended separation distance in metres (m).^b</p> <p>Field strengths from fixed RF transmitters, as determined by an electromagnetic site survey,^a should be less than the compliance level in each frequency range.^b</p> <p>Interference may occur in the vicinity of equipment marked with the following symbol.</p> 

NOTE 1: At 80 MHz and 800 MHz, the higher frequency range applies.

NOTE 2: These guidelines may not apply in all situations. Electromagnetic propagation is affected by absorption and reflection from structures, objects and people.

a: Field strengths from fixed transmitters, such as base stations for radio (cellular / cordless) telephones and land mobile radios, amateur radio, AM and FM radio broadcast and TV broadcast cannot be predicted theoretically with accuracy. To assess the electromagnetic environment due to fixed RF transmitters, an electromagnetic site survey should be considered. If the measured field strength in the location in which Vital Signs Monitor is used exceeds the applicable RF compliance level above, Vital Signs Monitor should be observed to verify normal operation. If abnormal performance is observed, additional measures may be necessary, such as re-orienting or relocating Vital Signs Monitor.

b: Over the frequency range 150 kHz to 80 MHz, field strengths should be less than 3V/m.

Table 4

Recommended separation distances between portable and mobile RF communications equipment and The equipment or system- for EQUIPMENT and SYSTEM that are not LIFE-SUPPORTING

Vital Signs Monitor is intended for use in an electromagnetic environment in which radiated RF disturbances are controlled. The customer or the user of the equipment or system can help prevent electromagnetic interference by maintaining a minimum distance between portable and mobile RF communications equipment (transmitters) and the equipment or system as recommended below, according to the maximum output power of the communications equipment.			
Rated maximum output power of transmitter W	Separation distance according to frequency of transmitter m		
	150kHz to 80MHz $d = 1.2 \sqrt{P}$	80MHz to 800MHz $d = 1.2 \sqrt{P}$	80MHz to 2,5GHz $d = 2.3 \sqrt{P}$
0,01	0.12	0.12	0.23
0,1	0.38	0.38	0.73
1	1.2	1.2	2.3
10	3.8	3.8	7.3
100	12	12	23
For transmitters rated at a maximum output power not listed above, the recommended separation distance d in meters (m) can be determined using the equation applicable to the frequency of the transmitter, where p is the maximum output power rating of the transmitter in watts (W) according to the transmitter manufacturer.			
NOTE 1: At 80 MHz and 800 MHz, the separation distance for the higher frequency range applies.			
NOTE 2: These guidelines may not apply in all situations. Electromagnetic propagation is affected by absorption and reflection from structures, objects and people.			

Chapter 7 Packaging and Accessories

7.1 Packaging

The product is packed in high quality corrugated cartons with foam inside to protect the equipment against damage in the shipping and handling process.

Weight: Details see the indication on the outer package.

Dimension: 360(L)×320(W)×410(H) (mm)

7.2 Accessories

(1) NIBP cuff	One piece
(2) SpO ₂ probe	One piece
(4) Power cord	One piece
(5) Grounding wire	One piece
(6) User manual	One copy
(7) Quality Certificate	One copy
(8) Warranty	Two copies
(9) Packing list	Two copies

Note: The accessories are subject to change. Refer to the package for the detailed items and quantity.

Chapter 8 Monitoring Parameter

8.1 NIBP Monitoring

8.1.1 Measuring Principle

Blood pressure may be measured in an invasive way (whereby the sensor will be inserted into blood vessel directly) or a non-invasive way. The non-invasive way includes several methodologies, such as the Korotkoff Sound Method and oscillating method. The Korotkoff Sound Method is used as a conventional way, whereby stethoscope is used to measure the blood pressure. By the oscillating method, an inflation pump will fill the air, and release it slowly. A computer will record change of the cuff pressure when the air is released. With this record, the blood pressure value will be determined. First of all, make sure the signal quality judgment by computer meets the requirements of accurate calculation (such as sudden limb movement or cuff being hit during the measurement). If the answer is negative, give up the calculation. If the answer is positive, proceed with calculation of the blood pressure value.

As change of the blood pressure is recorded by electric sensor, which sensitivity is much higher than that of human ears, the oscillating method uses different definitions for measurement of diastolic pressure, mean arterial pressure and systolic pressure from the Korotkoff Sound Method. When the oscillating method is used, the circuit in the measuring apparatus will separate the amplitude of the cuff pressure from its change with pulsation. With the oscillating method, the blood pressure at the maximum amplitude of cuff pressure is defined as the mean arterial pressure. The blood pressure at amplitude of cuff pressure forward reduced according to proper proportion is defined as systolic pressure, while the blood pressure at amplitude of cuff pressure backward reduced according to proper proportion is defined as diastolic pressure. The maximum change of pulse pressure occurs at these two points. They are equivalent to the point with pulse sound and the point without pulse sound respectively in the Korotkoff Sound Method.

When the risk of invasive monitoring method outweighs its advantage of accuracy, non-invasive monitoring method shall be used.

Comparison between blood pressure measuring methods

To overcome the effect of human hearing variation and air release speed on measurement accuracy when the conventional Korotkoff Sound Method is used to take measure of blood pressure, people have been dedicated to study of automatic measurement of blood pressure. By now, automatic blood pressure measuring system based on the principle of oscillating method is mature. In practice, however, various problems are encountered, such as why the measures taken by the oscillating method is lower or higher than those taken by Korotkoff Sound Method? Why the measures are inclined to decline? Why, in some cases, no result is obtained in spite of the inflation actions? Why the measure values have big discreteness and even abnormal data in some cases? Why the SpO₂ waveforms may disappear suddenly? ...and so on. The following explanations are devised to give the answers.

The Oscillating method vs. the Korotkoff Sound Method

Blood pressure measurement by the oscillating method and Korotkoff Sound Method has good correlation with the invasive measurement. Notwithstanding, any of the non-invasive blood pressure measurements has its one-sidedness when it is compared to the invasive measurement. The oscillating method has its advantages over

the Korotkoff Sound Method in less error, higher reliability and stability. Their differences may be reflected in the following aspects.

1. The measures by the Korotkoff Sound Method are liable to effect of human factors. For example, different people may have different sound judging ability, or different reactivity when listening to heart sound and reading mercury meter. The air release speed and subjectivity may also affect the judgment. By the oscillating method, the computation is accomplished by the computer, thus relieving the possibility of effect due to human factor.
2. With the Korotkoff Sound Method, the measure is taken on the basis of appearance and disappearance of heart sound. The air release speed and heart rate may have direct effect on the measurement accuracy. It also has the disadvantages of rapid air release and poor accuracy. In the contrast, with the oscillating method, the determination is calculated on the basis of cuff pressure oscillatory waveform envelope, and the air release speed and heart rate has little effect on the measurement accuracy.
3. Statistics show that, when measuring the hypertension, the measure taken by the oscillating method is likely to be lower than that taken by the Korotkoff Sound Method. When measuring the hypotension, the measure taken by the oscillating method is likely to be higher than that by the Korotkoff Sound Method. But, it doesn't mean the advantages or disadvantages between the oscillating method and the Korotkoff Sound Method. Comparison with the results taken by more accurate method, let's say comparison of the invasive pressure result with the output value by the blood pressure measuring simulator, will show which method has more accurate results. In addition, higher or lower value should be a statistical concept. It is recommended those used to adopt the Korotkoff Sound Method use different physiological calibration for values determined by the oscillating method.
4. The studies have shown that the Korotkoff Sound Method has the worst accuracy when it comes to measurement of hypotension, while the oscillating method has worse accuracy when it comes to measurement of controlled hypertension relief.

8.1.2 Factors affecting NIBP measuring

- ✧ Select a cuff of appropriate size according to the age of the subject.
- ✧ Its width should be 2/3 of the length of the upper arm. The cuff inflation part should be long enough to permit wrapping 50-80% of the limb concerned.
 Prior to use of the cuff, empty the cuff until there is no residual air inside it to ensure accurate measurement.
 Make the cuff mark ϕ in the position where artery pulsates obviously, the effect will be best.
 The lower part of cuff shall 2cm above the elbow joint.
- ✧ Do not wrap the cuff on too thick clothes(especially for cotton-padded clothes and sweater) to take measurement;
- ✧ The testee shall lie in bed or sit in chair, make the cuff and heart at the same level, the result will be most accurate, other postures may have inaccurate result;
- ✧ During measuring, do not move your arm or the cuff;
- ✧ The measuring interval shall longer than 2 minutes, in continuous measurement, too short interval may cause arm extrusion, blood quantity increases, then cause blood pressure increases.
- ✧ Keep the patient still and stop talking before and during measuring;
- ✧ The patient's mood also can affect the measuring result, when exciting, the blood pressure goes up.
- ✧ The measuring result also affected by time, lower in the morning and higher in the evening;

8.1.3 Clinical Limitations

1. Serious angiospasm, vasoconstriction, or too weak pulse.
2. When extremely low or high heart rate or serious arrhythmia of the subject occurs. Especially auricular fibrillation will lead to unreliable or impossible measurement.
3. Do not take the measurement when the subject is connected with an artificial heart-lung machine.
4. Do not take the measurement when the subject uses diuresis or vasodilator.
5. When the subject is suffering from major hemorrhage, hypovolemic shock and other conditions with rapid blood pressure change or when the subject has too low body temperature, the reading will not be reliable, for reduced peripheral blood flow will lead to reduced arterial pulsation.
6. Subject with hyperadiposis;

In addition, statistics show that 37% people report blood pressure difference of no less than 0.80kPa(6mmHg) between the left and right arms, and 13% people report difference of no less than 1.47kPa (11mmHg).

Note: Some practitioners may report big discreteness or abnormal value of the blood pressure measures when the oscillating method is used. As a matter of fact, the so-called “big discreteness” must be a term in the sense of statistical significance of mass data. Abnormal data may be observed in some individual cases. It is normal in the scientific experiments. It may be caused by an apparent reason, or by an unknown factor in some cases. Such individual doubtful experimental data may be identified and eliminated using the special statistical technique. It is not a part of this manual. The practitioner may eliminate the apparently unreasonable data according to the experience.

8.2 SpO₂ Monitoring

8.2.1 Measuring Principle

Based on Lamber-Beer law, the light absorbance of a given substance is directly proportional with its density or concentration. When the light with certain wavelength emits on human tissue, the measured intensity of light after absorption, reflecting and attenuation in tissue can reflect the structure character of the tissue by which the light passes. Due to that oxygenated hemoglobin (HbO₂) and deoxygenated hemoglobin (Hb) have different absorption character in the spectrum range from red to infrared light (600nm~1000nm wavelength), by using these characteristics, SpO₂ can be determined. SpO₂ measured by this monitor is the functional oxygen saturation -- a percentage of the hemoglobin that can transport oxygen. In contrast, hemoximeters report fractional oxygen saturation – a percentage of all measured hemoglobin, including dysfunctional hemoglobin, such as carboxyhemoglobin or metahemoglobin.

8.2.2 SpO₂ Measurement Restrictions (interference reason)

- ✧ Intravascular dyes such as indocyanine green or methylene blue
- ✧ Exposure to excessive illumination, such as surgical lamps, bilirubin lamps, fluorescent lights, infrared heating lamps, or direct sunlight.
- ✧ Vascular dyes or external used color-up product such as nail enamel or color skin care
- ✧ Excessive patient movement
- ✧ Placement of a sensor on an extremity with a blood pressure cuff, arterial catheter, or intravascular line
- ✧ Exposure to the chamber with high pressure oxygen

- ✧ There is an arterial occlusion proximal to the sensor
- ✧ Blood vessel contraction caused by peripheral vessel hyperkinesias or body temperature decreasing

8.2.3 Low SpO₂ measuring value caused by pathology reason

- ✧ Hypoxemia disease, functional lack of HbO₂
- ✧ Pigmentation or abnormal oxyhemoglobin level
- ✧ Abnormal oxyhemoglobin variation
- ✧ Methemoglobin disease
- ✧ Sulfhemoglobinemia or arterial occlusion exists near sensor
- ✧ Obvious venous pulsations
- ✧ Peripheral arterial pulsation becomes weak
- ✧ Peripheral blood supply is not enough

8.2.4 Clinical Limitations

- ✧ As the measure is taken on the basis of arteriole pulse, substantial pulsating blood stream of subject is required. For a subject with weak pulse due to shock, low ambient/body temperature, major bleeding, or use of vascular contracting drug, the SpO₂ waveform (PLETH) will decrease. In this case, the measurement will be more sensitive to interference.
- ✧ For those with a substantial amount of staining dilution drug (such as methylene blue, indigo green and acid indigo blue), or carbon monoxide hemoglobin (COHb), or methionine (Me+Hb) or thiosalicylic hemoglobin, and some with icterus problem, the SpO₂ determination by this monitor may be inaccurate.
- ✧ The drugs such as dopamine, procaine, prilocaine, lidocaine and butacaine may also be a major factor blamed for serious error of SpO₂ measurements.
- ✧ As the SpO₂ value serves as a reference value for judgment of anemic anoxia and toxic anoxia, the measurement result of some patients with serious anemia may also present as good SpO₂ value.

8.2.5 Points to be noted in SpO₂ and Pulse Measuring

- ✧ The finger should be properly placed (see the attached illustration of this instruction manual), or else it may cause inaccurate measurement result.
- ✧ Make sure that capillary arterial vessel beneath the finger is penetrated through by red and infrared lights.
- ✧ The SpO₂ sensor should not be used at a location or limb tied with arterial or blood pressure cuff or receiving intravenous injection.
- ✧ Do not fix the SpO₂ sensor with adhesive tape, or else it may result in venous pulsation and consequential inaccurate measurement result of SpO₂.
- ✧ Make sure the optical path is free from any optical obstacles like adhesive tape.
- ✧ Excessive ambient light may affect the measuring result. It includes fluorescent lamp, dual ruby light,

infrared heater, and direct sunlight etc.

- ✧ Strenuous action of the subject or extreme electrosurgical interference may also affect the accuracy.
- ✧ Please do not use the SpO₂ sensor when having the MRI, or burn may be caused by faradism.
- ✧ Always observe the plethysmogram (waveform), which is auto-scaled within the range of 100. The SpO₂ reading may be unlikely true when the waveform is not smooth or irregular. If in doubt, rely on your clinical judgment, rather than the monitor readout.
- ✧ A functional tester cannot be used to assess the accuracy of the pulse oximeter monitor or a SpO₂ sensor. However, a functional tester, such as SpO₂ simulator can be used to check how accurately a particular pulse oximeter is reproducing the given calibration curve. Before testing the oximeter by a functional tester, please firstly ask the manufacturer which calibration curve is used, if necessary, request the manufacturer for its dedicated calibration curve and download it into the tester.

Chapter 9 Troubleshooting

9.1 No Display on the Screen

Shut down the machine and unplug the power. Use a universal meter to check if the outlet has proper voltage, if the power cable is in good condition, and if the power cable is properly connected with this apparatus or outlet. Remove the fuse from the back cover of this machine, and make sure it is in good condition.

9.2 No Blood Pressure and Pulse Oxygen Measures

1. Check if the blood pressure cuff is properly wrapped around the arm according to the operating instructions, if the cuff leaks, and if the inlet is closely connected with the NIBP jack on the side panel. Check if the indicator of the pulse oxygen probe flashes and if the pulse oxygen probe is properly connected to the SpO₂ jack on the side panel.
2. If the problems still exist, please contact the local dealer.

9.3 Blank Printing Paper

1. Check whether the printing paper is installed with its face reversed. Please reinstall it and let the sensitive page face upward.
2. If the problems still exist, please contact the local dealer.

9.4 System Alarm

1. When the parameter value is higher or lower than the alarm limits, the alarm will ring. Please check whether the alarm limit value is proper or the condition of the patient.
2. Probe off. Please check the connection of the probes.

Note: In case of trouble of this machine in the service, follow the instructions below to eliminate the problem first. If the attempt fails, contact the dealer in your local area or the manufacturer. Do not open the cabinet without permission.

Chapter 10 Maintenance

10.1 Service and Examination

10.1.1 Daily Examination

Before using the monitor, the checks below should be carried out:

- Check the monitor for any mechanical damage;
- Inspect the exposed parts and the inserted parts of all the leads, and the accessories;
- Examine all the functions of the monitor that are likely to be used for patient monitoring, and ensure that it is in good working condition;
- Make sure that the monitor is grounded properly.
- Pay close attention to the fluctuation of the local power supply voltage. A manostat is recommended when necessary.
- In case any indication of damage about the function of the monitor is detected and proven, it is not allowed to apply it to the patient for any monitoring.

10.1.2 Routine Maintenance

After each maintenance or the yearly maintenance, the monitor can be thoroughly inspected by qualified personnel, including function and safety examinations. The designed life of this monitor is 5 years. In order to ensure its long service life, please pay attention to the maintenance.

- ⚠ **If the hospital fails to carry out a satisfactory maintenance program about the monitor, it may get disabled and harm the patient's safety and health.**
- ⚠ **In case of ECG leads damage or aging, please replace the lead.**
- ⚠ **If there is any indication of cable and transducer damage or they deteriorate, they are prohibited from any further use.**
- 🔔 **The adjustable units in the monitor such as potentiometer are not allowed to adjust without permission to avoid unnecessary failures that affect normal application.**

10.1.3 Battery Maintenance

- ❖ **Please pay attention to the polarity of battery, do NOT insert it into battery compartment with reversed polarities;**
- ❖ **Do NOT use the batteries manufactured by other companies, if being inserted, the device will may be damaged;**
- ❖ **In order to avoid damaging the battery, do NOT use other power supply device to charge the battery;**
- ❖ **After battery ageing phenomenon occurring, to avoid explosion risk do NOT throw the battery into fire.**
- ❖ **Do not hit or strike it with force;**

- ✧ **Do not use this battery on other devices;**
- ✧ **Do not use this battery below -10°C or above 40°C;**
- ✧ **Dispose of the battery, the local law should be followed.**
 - 🔔 **In order to maintain battery supply time and prolong battery lifetime, please charge the battery every one or two months if don't use battery for a long time. And do charge battery at least 12-15 hours every time. Before connect to AC, do start monitor with battery's power supply, until battery power is used up and monitor turn off automatically, then connect monitor to AC and have it charged for 12-15 hours continuously. The speed of charge will be the same no matter whether the monitor is working or not. The reason why discharge the battery before charge is to avoid the decrease of capacity caused by battery's memory effect. If the monitor won't be used for a long time, do have it charged fully before conservation.**
 - 🔔 **Using a monitor powered solely by an internal battery power which has short charge power will cause the monitor turn off automatically when the battery is depleted.**
 - 🔔 **If battery is damaged, please replace with same type and specification battery marked by "CCC" or "CE" in time, or contact the company directly.**

10.1.4 Service

If the monitor has functional malfunction or is not working, please contact the local dealer or our company, and we are to offer the best solution as soon as possible for your satisfaction. Only qualified service engineer specified by the manufacture can perform the service. Users are not permitted to repair it by themselves.

10.2 Cleaning and Disinfection

- Kept the monitor from dust.
- It is recommended to clean the outer shell and screen of the monitor to keep it clean. Only non-corrosive cleanser such as clear water is permitted.
- Use the cloth with alcohol to wipe the surface of the monitor and transducers, and dry it with dry and clean cloth or simply air-dry.
- The monitor can be sterilized and disinfected, please clean it first.
- 🔔 **Switch off the monitor and disconnect the power cable before cleaning.**
- 🔔 **Do not let the liquid cleanser flow into the connector jack of the monitor to avoid damage.**
- 🔔 **Clean the exterior of the connector only.**
- 🔔 **Dilute the cleanser.**
- 🔔 **Do not let any liquid flow into the shell or any parts of the monitor.**
- 🔔 **Do not let the cleanser and disinfectant stay on its surface.**
- 🔔 **Do not perform high pressure sterilization to the monitor.**
- 🔔 **Do not put any parts of the monitor or its accessories in the liquid.**
- 🔔 **If the monitor is accidentally wetted it should be thoroughly dried before use. The rear cover can be removed by qualified service technician to verify absence of water.**

- 🔔 **Do not pour the disinfectant on its surface while disinfecting.**

10.3 Cleaning and Disinfection of Accessories

It is recommended to clean the accessories (including sensor, leads and plugs) with a piece of gauze which has been soaked in 75% Alcohol or 70% Isopropanol before use.

- 🚫 **Do not use damaged accessories.**
- 🚫 **Accessories can not be entirely immersed into water, liquor or cleanser.**
- 🚫 **Do not use radial, steam or epoxyethane to disinfect accessories.**
 - 🚫 **Do wipe off the remained alcohol or isopropanol on the accessories after disinfection, for good maintenance can extend the life of accessories.**

10.4 Storage

If the equipment will not be used for long period of time, wipe it clean and keep it in the packaging, which shall be kept in a dry and good ventilation place free from dust and corrosive gases.

Storage environment: ambient temperature: -20~60°C
relative humidity: 10%~95%
atmosphere: 50kPa~107.4kPa

10.5 Transportation

This monitor should be transported by land (vehicle or railway) or air in accordance with the contractual terms. Do not hit or drop it with force.

Transportation environment: ambient temperature: -20~60°C
relative humidity: 10%~95%
atmosphere: 50kPa~107.4kPa

Chapter 11 Appendix

11.1 Prompt information explanations

Mute C-D: XXX seconds	Alarm silence count down: XXX seconds
NIBP C-D: XXX seconds	NIBP auto measuring cycle count down: XXX seconds
TOUR C-D: XXX seconds	Hemostat alert count down: XXX seconds
Probe off	SpO ₂ probe falls off
PR over limit	PR value exceeds the high/low alarm limit
SpO ₂ over limit	SpO ₂ value exceeds the high/low alarm limit
SYS over limit	Systolic pressure value exceeds the high/low alarm limit
DIA over limit	Diastolic pressure value exceeds the high/low alarm limit
MAP over limit	MAP value exceeds the high/low alarm limit
NIBP error 1#	Sensor or other hardware error
NIBP error 2#	Very weak signal because of the cuff, or the patient has very weak pulse
NIBP error 3#	Blood pressure amplifier overflow due to excessive movement
NIBP error 4#	Leaking during the pneumatic device testing
Cuff error	Cuff is not wrapped correctly, or is not connected
NIBP error 5#	Abnormal condition of CPU, such as register overflow, divided by zero
Air leak	Air moving part, tube or the cuff leak air
NIBP over range	The measurement range exceeds 255mmHg (for neonates: over 135 mmHg)
Over motion	The repeated measurement due to moving, excessive noise during the stepping inflation and measuring pressure and pulse, e.g. during patient shaking motion
Over pressure	Cuff press exceeds the safety limit value of software. Limit value for adult: 290mmHg; Limit value for pediatric: 145mmHg; Or caused by cuff extrusion or flapping cuff with force.
NIBP timeout	Adult measurement is more than 120 seconds, neonate measurement is more than 90 seconds.

11.2 Default Alarming Values and Setup Range

The default alarming value:

Parameter \ Mode		Adult	Pediatric	Neonate
SYS	High limit	180mmHg	130mmHg	110mmHg
	Low limit	60mmHg	50mmHg	50mmHg
DIA	High limit	120mmHg	90mmHg	90mmHg
	Low limit	50mmHg	40mmHg	30mmHg
MAP	High limit	160mmHg	110mmHg	100mmHg
	Low limit	50mmHg	40mmHg	30mmHg
SpO ₂	High limit	100%	100%	100%
	Low limit	90%	85%	85%
Pulse rate	High limit	180bpm	200bpm	220bpm
	Low limit	40bpm	50bpm	50bpm

The high and low limits setting range:

Parameter \ Mode		Adult	Pediatric	Neonate
SYS	High limit	(30~280) mmHg	(30~200) mmHg	(30~135) mmHg
	Low limit	(29~279) mmHg	(29~199) mmHg	(29~134) mmHg
DIA	High limit	(11~232) mmHg	(11~150) mmHg	(11~100) mmHg
	Low limit	(10~231) mmHg	(10~149) mmHg	(10~99)mmHg
MAP	High limit	(21~242) mmHg	(21~165) mmHg	(21~110) mmHg
	Low limit	(20~241) mmHg	(20~164) mmHg	(20~109)mmHg
SpO ₂	High limit	1~100%	1~100%	1~100%
	Low limit	0~99%	0~99%	0~99%
Pulse rate	High limit	(1~300) bpm	(1~350) bpm	(1~350) bpm
	Low limit	(0~299) bpm	(0~349) bpm	(0~349) bpm

Note: Alarm signal (for any alarm source) generation delay time: <1 sec, refer to the monitor in your hand.

11.3 Accessories List

Part No.	Part Name	Remark
15044051	Adult SpO ₂ Finger clip sensor	
15044061	Adult SpO ₂ Finger rubber sensor	Optional
15044041	Pediatric SpO ₂ Finger clip sensor	Optional
15044063	Neonate SpO ₂ Y-type sensor	Optional
15024402	Adult NIBP cuff(25~35cm)	
15021402	Small-sized Pediatric NIBP cuff	Optional
15022402	Middle-sized Pediatric NIBP cuff	Optional
15023402	Large-sized Pediatric NIBP cuff	Optional
15020400	Neonate NIBP cuff(5.4*9.1cm)	Optional
5101-5236310	Thermal printer paper	Optional
2903-0000000	Power cord	
2911-0003032	Grounding wire	
900093	Net wire	Optional

For more information regarding the accessories, please contact your local sales representative or the manufacturer.

Note: Part no. is subject to change without prior notice, please refer to the label of parts or Packing List.

11.4 Instructions for SpO₂ Probe

Instructions for Pediatric SpO₂ Finger Clip Sensor

Intended Use

When used with a compatible patient monitor or a pulse oximeter device, the sensor is intended to be used for continuous, non-invasive functional arterial oxygen saturation (SpO₂) and pulse rate monitoring for pediatric patients weighing between 10~40kg.

Contraindications

This sensor is contraindicated for use on active patients or for prolonged use.

Instructions for Use

- 1) With the upper and lower jaws open, place an index finger evenly on the base of the clip. Push the finger tip against the stop so that it is over the sensor window . If an index finger cannot be positioned correctly, or is not available, other fingers can be used.
- 2) Note: When selecting a sensor site, priority should be given to an extremity free of an arterial catheter, blood pressure cuff, or intravascular infusion line.
- 3) Spread open the rear tabs of the sensor to provide even force over the length of the pads .
- 4) The sensor should be oriented in such a way that the cable is positioned along the top of the hand .

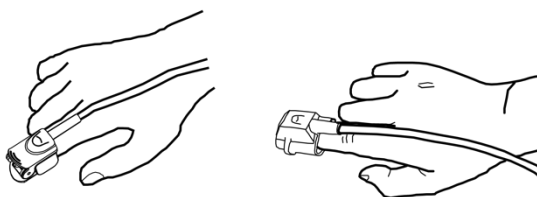

- 5) Plug the sensor into the oximeter and verify proper operation as described in the oximeter operator's manual.
- 6) Inspect the monitoring site every 4 hours for skin integrity.
- 7) Before each use, surface-clean sensor and cable with a soft gauze pad by saturating it with a solution such as 70% isopropyl alcohol. If low-level disinfection is required, use a 1:10 bleach solution.

Caution: Do not sterilize by irradiation steam, or ethylene oxide.

Warnings

- 1) Some factors may affect the accuracy of saturation measurements. Such factors include: excessive patient motion, fingernail polish, use of intravascular dyes, excessive light, poor blood perfusion in the finger, extreme finger sizes or improper placement of the sensor.
- 2) Using the sensor in the presence of bright lights may result in inaccurate measurements. In such cases, cover the sensor site with an opaque material.
- 3) The sensor must be moved to a new site at least every 4 hours. Because individual skin condition affects the ability of the skin to tolerate sensor placement, it may be necessary to change the sensor site more frequently with some patients. If skin integrity changes, move the sensor to another site.
- 4) Do not apply tape to secure the sensor in place or to tape it shut; venous pulsation may lead to inaccurate saturation measurements.
- 5) Do not immerse sensor as it causes short.
- 6) Do not use NIBP or other constructing instruments on same appendage as sensor for blood flow interrupted by NIBP cuff or circulatory patient condition will result in no pulse found or loss of pulse.
- 7) Do not use the sensor or other oximetry sensors during MRI scanning.

- 8) Carefully route cables to reduce the possibility of patient entanglement or strangulation.
- 9) Do not alter or modify the sensor. Alterations or modifications may affect performance or accuracy.
- 10) Do not use the sensor if the sensor or the sensor cable appears damaged.

Instructions for Adult SpO₂ Finger Rubber Sensor

Intended Use

When used with a compatible patient monitor or a pulse oximeter device, this SpO₂ sensor is intended to be used for continuous, non-invasive functional arterial oxygen saturation (SpO₂) and pulse rate monitoring for patients weighing greater than 50kg.

Contraindications

This sensor is contraindicated for use on active patients or for prolonged use.

Instructions for Use

- 1) Hold the sensor with its opening towards the patient's index finger (A). The sensor should be oriented in such a way that the sensor side with a finger tip sign is positioned on the top.
- 2) Insert the patient's index finger into the sensor until the fingernail tip rests against the stop at the end of the sensor. Adjust the finger to be placed evenly on the middle base of the sensor. Direct the cable along the top of the patient's hand. Apply adhesive tape to secure the cable (B). If an index finger cannot be positioned correctly, or is not available, other fingers can be used.
- 3) Plug the sensor into the oximeter and verify proper operation as described in the oximeter operator's manual.
- 4) Inspect the monitoring site every 4 hours for skin integrity.

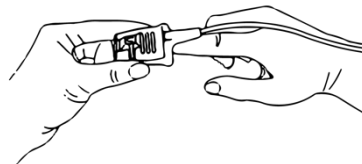

(A)

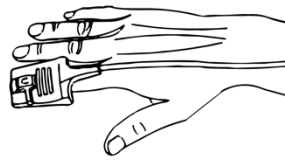

(B)

Cleaning & Disinfection

Unplug the sensor before cleaning or disinfecting. Surface-clean sensor and cable with a soft gauze pad by saturating it with a solution such as 70% isopropyl alcohol. If low-level disinfection is required, use a 1:10 bleach solution.

Caution: Do not sterilize by irradiation steam, or ethylene oxide.

Warnings

- 1) This sensor is for use only with compatible patient monitors or pulse oximeter devices. Use of this sensor with instruments other than compatibles may result in improper performance.
- 2) Some factors may affect the accuracy of saturation measurements. Such factors include: excessive patient motion, fingernail polish, use of intravascular dyes, excessive light, poorly perfused finger, extreme finger sizes or improper placement of the sensor.
- 3) The sensor site must be checked for skin integrity at least every 4 hours. Because individual skin condition affects the ability of the skin to tolerate sensor placement, it may be necessary to change the sensor to another finger.
- 4) Do not use NIBP or other constraining instruments on same appendage as sensor for blood flow interrupted by NIBP cuff or circulatory patient condition will result in no pulse found or loss of pulse. Do

not use the sensor during MRI scanning.

- 5) Carefully route cables to reduce the possibility of patient entanglement or strangulation.
- 6) Do not alter or modify the sensor. Alterations or modifications may affect performance or accuracy.
- 7) Do not use the sensor if the sensor or the sensor cable appears damaged.

Instructions for Adult SpO₂ Finger Clip Sensor

Intended Use

When used with a compatible patient monitor or a pulse oximeter device, the sensor is intended to be used for continuous, non-invasive functional arterial oxygen saturation (SpO₂) and pulse rate monitoring for patients weighing greater than 40kg.

Contraindications

This sensor is contraindicated for use on active patients or for prolonged use.

Instructions for Use

- 1) With the upper and lower jaws open, place an index finger evenly on the base of the clip. Push the finger tip against the stop so that it is over the sensor window . If an index finger cannot be positioned correctly, or is not available, other fingers can be used.
- 2) Note: When selecting a sensor site, priority should be given to an extremity free of an arterial catheter, blood pressure cuff, or intravascular infusion line.
- 3) Spread open the rear tabs of the sensor to provide even force over the length of the pads .
- 4) The sensor should be oriented in such a way that the cable is positioned along the top of the hand .

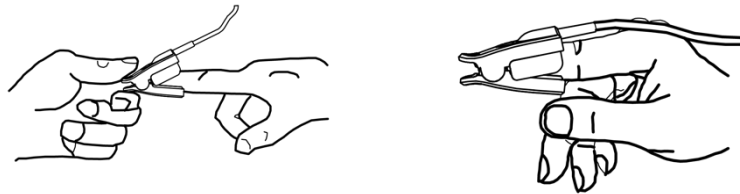

- 5) Plug the sensor into the oximeter and verify proper operation as described in the oximeter operator's manual.
- 6) Inspect the monitoring site every 4 hours for skin integrity.
- 7) Before each use, surface-clean sensor and cable with a soft gauze pad by saturating it with a solution such as 70% isopropyl alcohol. If low-level disinfection is required, use a 1:10 bleach solution.

Caution: Do not sterilize by irradiation steam, or ethylene oxide.

Warnings

- 1) Some factors may affect the accuracy of saturation measurements. Such factors include: excessive patient motion, fingernail polish, use of intravascular dyes, excessive light, poorly perfused finger, extreme finger sizes or improper placement of the sensor.
- 2) Using the sensor in the presence of bright lights may result in inaccurate measurements. In such cases, cover the sensor site with an opaque material.
- 3) The sensor must be moved to a new site at least every 4 hours. Because individual skin condition affects the ability of the skin to tolerate sensor placement, it may be necessary to change the sensor site more frequently with some patients. If skin integrity changes, move the sensor to another site.
- 4) Do not apply tape to secure the sensor in place or to tape it shut; venous pulsation may lead to inaccurate saturation measurements.
- 5) Do not immerse sensor as it causes short.
- 6) Do not use NIBP or other constructing instruments on same appendage as sensor for blood flow













interrupted by NIBP cuff or circulatory patient condition will result in no pulse found or loss of pulse.

- 7) Do not use the sensor or other oximetry sensors during MRI scanning.
- 8) Carefully route cables to reduce the possibility of patient entanglement or strangulation.
- 9) Do not alter or modify the sensor. Alterations or modifications may affect performance or accuracy.
- 10) Do not use the sensor if the sensor or the sensor cable appears damaged.

We offer a 6-month warranty against manufacturing defects for the SpO₂ sensors mentioned above in its undamaged condition.

If you have any question regarding any of SpO₂ sensor instructions, please contact your local dealer.

Explanation of Symbols in the Monitor

	Caution: read instructions (warnings) carefully
	Serial number
	WEEE disposal
	Keep in a cool, dry place
	Manufacturer
	Date of manufacture
	Authorized representative in the European community
	Defibrillation-proof type BF applied part
	Follow instructions for use
	Defibrillation-proof type CF applied part
	Medical Device complies with Directive 93/42/EEC
	Product code
	Keep away from sunlight



Disposal: *The product must not be disposed of along with other domestic waste. The users must dispose of this equipment by bringing it to a specific recycling point for electric and electronic equipment.*

GIMA WARRANTY TERMS

The Gima 12-month standard B2B warranty applies.