

UM-102

Digital Sphygmomanometer

Instruction Manual	Original
Manuel d'instructions	Traduction
Manual de instrucciones	Traducción
Manuale di Istruzioni	Traduzione
使用手冊	翻譯

UM-102

Digital Sphygmomanometer

Instruction Manual

Contents

1.	Dear Customers	2
2.	Preliminary Remarks	3
3.	Notes for Proper Use.....	4
4.	Parts Identification	7
5.	Symbols.....	8
6.	Using the Monitor	9
7.	Measurements.....	13
8.	Useful Features	14
9.	Troubleshooting.....	15
10.	Maintenance	15
11.	Technical Data	16

1. Dear Customers

Congratulations on purchasing a state-of-the-art A&D sphygmomanometer, one of the most advanced monitors available on the market today. Designed for ease of use and accuracy. We recommend that you read through this manual carefully before using this device for the first time.

- Applicable Patient:** The device is designed for use on adults only, not newborns or infants.
- Environment for Use:** The device is for indoor use.
- Intended purpose:** This device is designed to measure blood pressure and pulse rate of people for diagnosis.

Features

Measurement

- This sphygmomanometer is designed to monitor and display the cuff pressure during cuff inflation and deflation while the healthcare provider determines the patient's blood pressure level by listening for Korotkoff sounds with a stethoscope.

Safety

- This sphygmomanometer is designed to measure a patient's blood pressure without the use of mercury, therefore protecting your local environment.
- An automatic quick exhaust valve is installed in the device to prevent over pressurization of 300mmHg or higher, therefore protecting the patient.

2. Preliminary Remarks

Compliance

- This device conforms to the European Directive 93/42 EEC for Medical Products. This is made evident by the **CE**₀₁₂₃ mark of conformity. (0123: The reference number to the involved notified body)

Definitions

SYS	Systolic Blood Pressure
DIA	Diastolic Blood Pressure
PUL	Pulse
Exhaust	This means “releasing the cuff air as soon as possible”.
Constant exhaust	This means, “releasing the cuff air at a constant depressurization rate”.

Batteries

- Use alkaline batteries (LR6 type, AA type) or equivalent batteries.
- Do not mix new and used batteries.
- Remove the batteries if the device will not be in use for a prolonged period of time as the batteries may leak and cause a device malfunction.
- The battery life varies with the ambient temperature and may be shorter at low temperatures. Generally, two new LR6 batteries will last approximately for two months when used forty times for measurement each day.

A Defective Sphygmomanometer

- Stop using the device immediately if the device does not work properly. Please attach a note with the following "Do not use this sphygmomanometer" to prevent any further use. This defective device should be stored in a safe place to avoid any misuse until it has been sent for repair.

Repair

- Do not attempt to open the device. Contact your nearest A&D authorized dealer and they will repair or replace the device.
- Do not modify the device. It may cause accidents or damage to the device.

Blood Pressure Measurement

- ❑ Do not use the device on patients using heart-lung support equipment.
- ❑ Do not use the device on patients in a critical condition or on ICU (intensive care unit) patients.
- ❑ The healthcare provider should stop using the device if there is an abnormality, such as a patient feeling excessive arm pain, and remove the cuff to protect the patient.

Contraindications

- ❑ Do not apply the cuff to an arm with another medical electrical equipment attached. The equipment may not function properly.
- ❑ Do not apply the cuff on an arm with an unhealed wound.
- ❑ Do not apply the cuff on an arm receiving an intravenous drip or blood transfusion. It may cause injury or accidents.
- ❑ Do not use the device where flammable gases such as anesthetic gases are present. It may cause an explosion.
- ❑ Do not use the device in highly concentrated oxygen environments, such as a high-pressure oxygen chamber or an oxygen tent. It may cause a fire or explosion.
- ❑ When the cuff is infected by blood or body fluid, it should be safely disposed of according to local instructions or protocol to avoid any potential spread of infectious disease.

3. Notes for Proper Use

Storage

- ❑ Do not store the device where it could be splashed with water or other liquids. The device and cuff are not water resistant. If the device is immersed by accident, it may require servicing. (Do not use the device before it has endured a full service.)
- ❑ Do not store the device in a high temperature or high humidity environment, or in direct sunlight.
- ❑ Do not store the device where it could be influenced by vibration or shock.
- ❑ Do not store the device in a dusty, salty or sulfuric environment.
- ❑ Do not store the device where medicines are stored, or where medicines are evaporating.

Before Use

- ❑ Make sure that the device works correctly and that measurement values are accurate.
- ❑ Make sure that the cuff and air hoses are properly connected.
- ❑ Check and maintain the cleanliness of the parts in direct contact with the patient.
- ❑ Avoid placing the device near a strong magnetic field or static electricity.
- ❑ Avoid placing the device near high frequency surgical equipment.
- ❑ When reusing the device, confirm that the device is clean.

During Use

- ❑ This device should be used by trained professionals.
- ❑ Stop using the device immediately, if the patient feels pain during a measurement or if the device does not work properly.
- ❑ Stop using the device if you notice any abnormalities (for example; liquid inside the device) and request a full service.
- ❑ To measure blood pressure, the arm must be squeezed by the cuff hard enough to temporarily stop blood flow through the artery. This may cause pain, numbness or a temporary red mark to the arm. This condition will appear especially when measurement is repeated successively.
Any pain, numbness, or red marks will disappear with time.
- ❑ This is a device which needs to handle with care. Strong impact may result in malfunction of the device.
- ❑ Be careful not to get hurt when handling the damaged device.
- ❑ Do not replace the batteries during use of the device.
- ❑ Do not touch the batteries and the patient at the same time.
- ❑ If the batteries are short-circuited in the state of single fault condition, the batteries may become hot and there is a risk of burns.

After Use

- ❑ Clean the device, cuff and accessories with a dry, soft cloth or a wet cloth with water or a neutral detergent. Do not pull or kink the hoses. Do not use any organic solvent, (antiseptic solution or other harsh chemicals) to clean the device, cuff or accessories.
- ❑ Press  button to turn off the power after measurement.
- ❑ Keep the original box for further transportation after purchasing the device.
- ❑ Be careful not to get your fingers caught when folding the device.

Periodic Maintenance

- ❑ This device is a precision instrument and contains electronic circuitry. Please check all functions periodically. Contact your nearest A&D authorized dealer for official calibration/check-up, according to your local regulations.
- ❑ Used equipment, parts and batteries are not treated as ordinary household waste, and must be disposed of according to the applicable local regulations.

How to Take Proper Measurements

For the most accurate blood pressure measurement:

- ❑ Confirm that a patient does not cross the legs, patient's legs touch on the floor and patient's back and arms are supported.
- ❑ Let a patient relax for about five to ten minutes before measurement.
- ❑ Place the center of the cuff at the same height as a patient's heart.
- ❑ A patient must remain still and keep quiet during measurement.
- ❑ Do not measure right after exercising or taking a bath. A patient must rest for twenty to thirty minutes before the measurement.

Notes for Proper Measurement

- ❑ Let a patient sit down in a comfortable position. Let a patient place the arm on a table with the palm facing upward and the cuff at the same level as patient's heart.
- ❑ Let a patient relax for about five to ten minutes before taking a measurement. If a patient is excited or depressed by emotional stress, the measurement will reflect this stress as a higher (or lower) than normal blood pressure reading and the pulse reading will usually be faster than normal.
- ❑ An individual's blood pressure varies constantly, depending on what a patient is doing and what a patient has eaten. What a patient drinks can have a very strong and rapid effect on patient's blood pressure.
- ❑ Should the device detect a condition that is abnormal, it will stop the measurement and display an error symbol. Refer to page 8 for the description of symbols.
- ❑ This sphygmomanometer is intended for adults only. Do not use this device to children.

4. Parts Identification

Main Body and Accessories

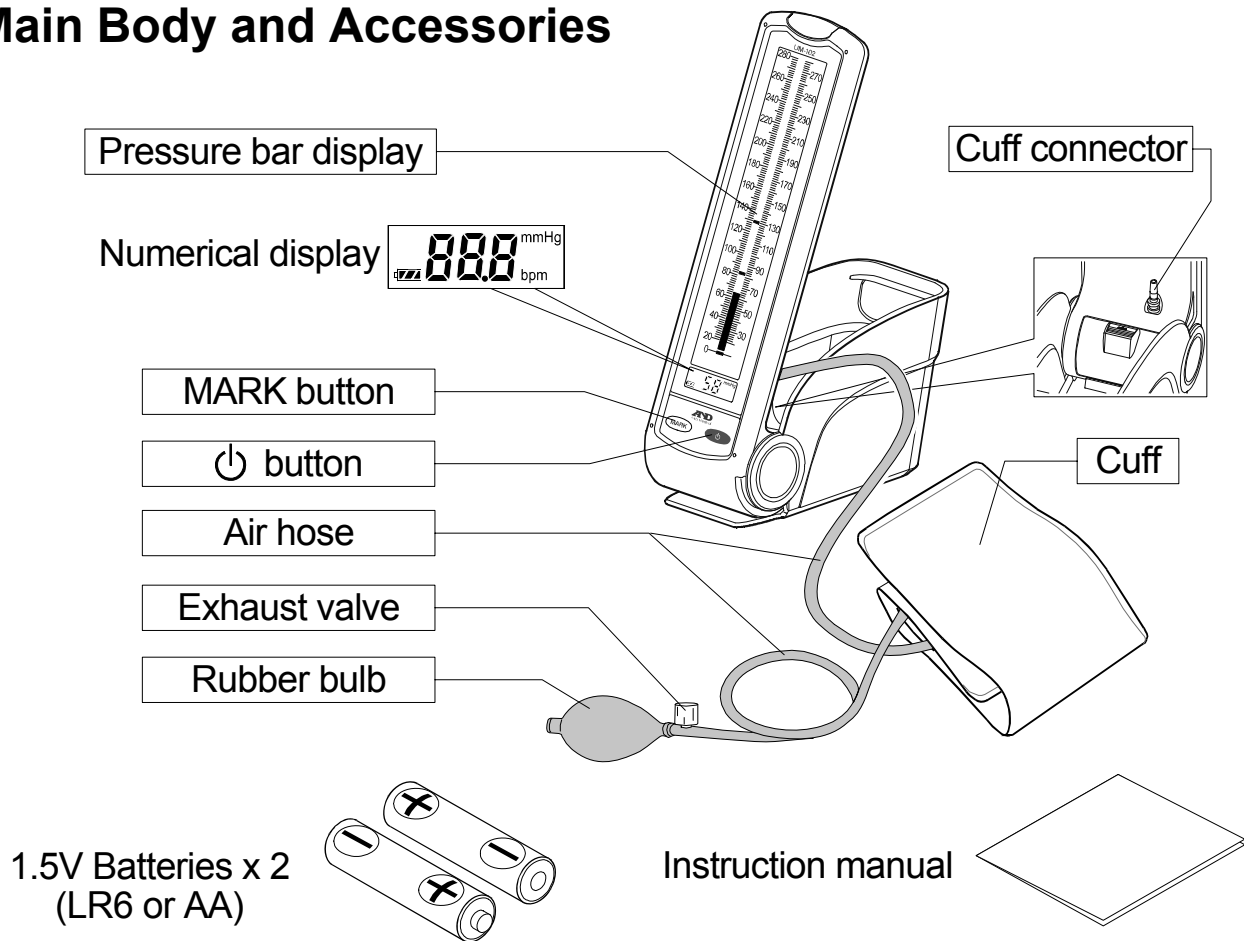





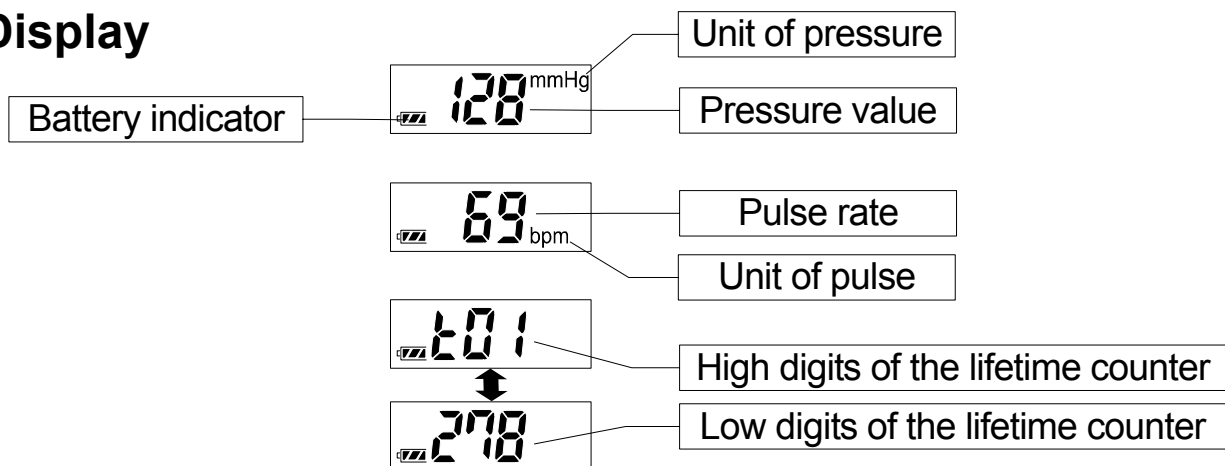



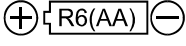

	Function
Power button	Turns on or off the device.
MARK button	During measurement Puts a marker at a pressure value After turned off..... Indicates a lifetime counter
Numerical display	During measurement Indicates pressure value After exhausted air..... Indicates pulse rate

Display



5. Symbols

Symbols	Function / Meaning	Recommended Action
	Standby and Turn the device on	—
MARK	Pressure value holding and lifetime counter	—
	Battery installation guide	—
SN	Serial number	—
2015 	Date of manufacture	—
	Type BF: Device, cuff and tubing are designed to provide special protection against electrical shocks.	—
	Full Battery The battery power indicator during measurement.	—
	Low Battery The battery is low when it blinks.	Replace all batteries with new ones, when the indicator blinks.
<i>Er 1</i>	Pressure remains in the cuff.	Exhaust it with the exhaust valve.
<i>Er 2</i>	Measurement overtime	
<i>Er 3</i>	Device is out of order.	Send for service.
<i>Err</i>	The pulse is not detected correctly.	Take another measurement.
mmHg	Unit of pressure	—
bpm	Unit of pulse	—
	EC directive medical device label	—
	WEEE label	—
	Manufacturer	—
	EU-representative	—
	Refer to instruction manual/booklet	—
	Warning; Hot surface	—

6. Using the Monitor

Installing / Changing the Batteries

1. Remove the battery cover.
2. Insert a new set of batteries into the battery compartment as shown. Make sure the polarities (+) and (-) are correct. Use only LR6, AA or equivalent batteries.
3. Close the battery cover.

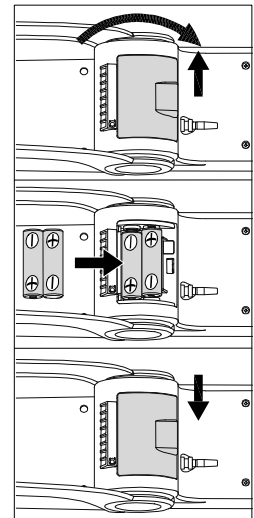

CAUTION

- ❑ Insert the batteries in the battery compartment. If not, the device will not work.
- ❑ When  (LOW BATTERY mark) blinks in the LCD display, replace all batteries with new ones. Do not mix old and new batteries. It may shorten the battery life, or cause the device to malfunction.
- ❑ The battery life varies with the ambient temperature and may be shorter at low temperatures.
- ❑ Use the specified batteries only. The batteries provided with the device are for testing the device performance and may have a limited life.
- ❑ Remove the batteries if the device will not be in use for a prolonged period of time as the batteries may leak and cause a device malfunction.

Connecting the Air Hose

Insert the air hose into the cuff connector firmly.

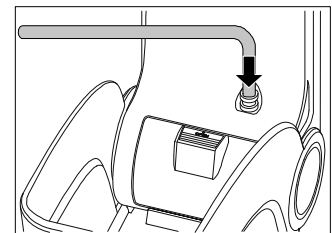

Connecting the Connector and Plug for the Cuff

(Sold separately)

1. Insert the air hose socket into the cuff connector .

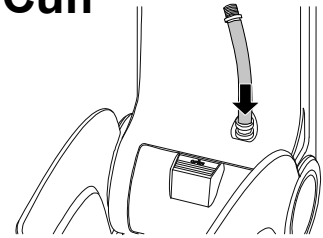

2. Insert the air hose plug to the air hose of the cuff.

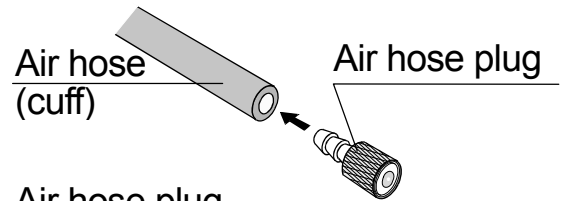

3. Connect the air hose plug of the cuff to the air hose socket of the main body.

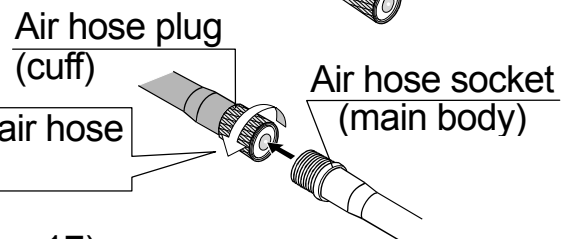

□ Use the specified connector. (Refer to page 17)

Installing the Device to Mobile Stand (Sold separately)

Install the device with the included four screws to mobile stand.

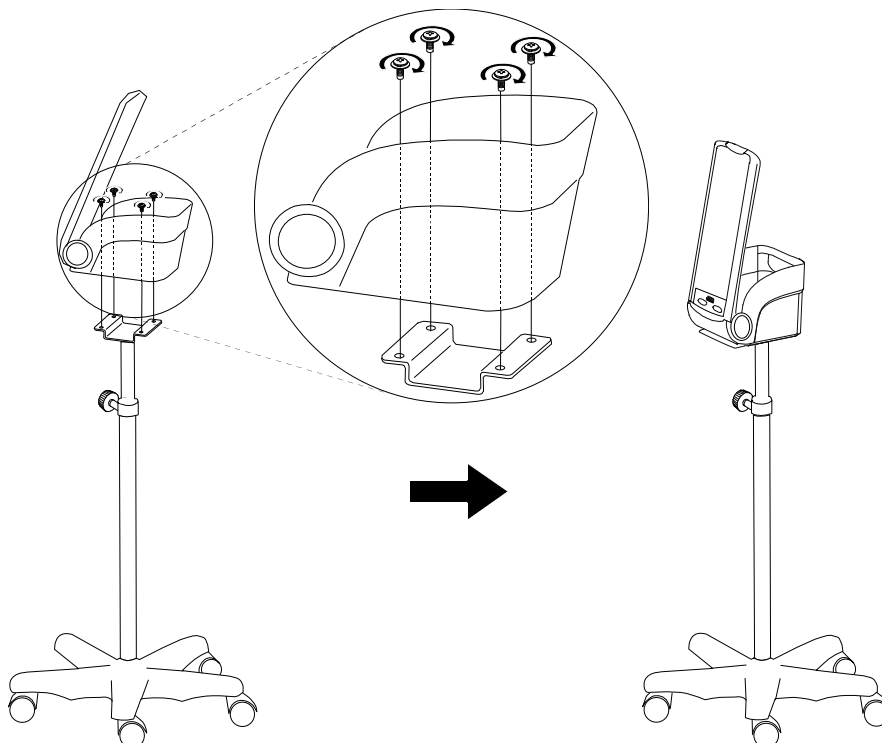

Selecting the Proper Cuff

Using the correct cuff size is important for accurate readings. If the cuff is not the proper size, the reading may yield an incorrect blood pressure value.

- The INDEX and RANGE markings on the cuff will indicate that you are using the proper cuff or not. (Refer to "**Attaching the Arm Cuff**" in the next section)

Arm Size	Cuff Size	Catalog Number
41 cm to 50 cm	LL cuff	CUF-KW-LL
31 cm to 45 cm	Large Adult cuff	CUF-KW-LA
22 cm to 32 cm	Adult cuff	CUF-KW-A
16 cm to 24 cm	Small Adult cuff	CUF-KW-SA
12 cm to 17 cm	SS cuff	CUF-KW-SS

Arm size: The circumference of the biceps

Attaching the Arm Cuff

1. Wrap the cuff around the upper arm, about 1 to 2 cm above the elbow as shown on the right. Place the cuff directly against the skin, as clothing may cause a faint pulse and could result in a measurement error.
2. Constriction of the upper arm, caused by rolling up a shirtsleeve, may interfere with accurate readings.
3. Make sure that the index points are within the range.

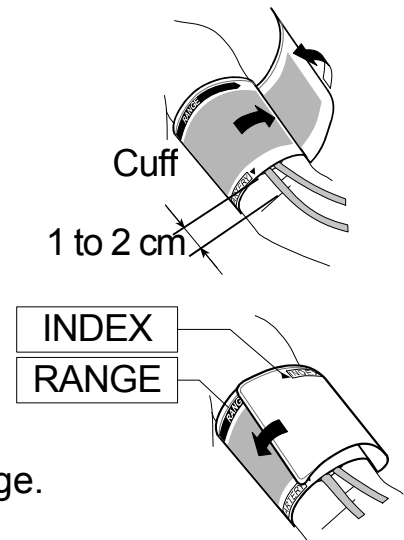

Symbols that are printed on the cuff



Symbols	Function / Meaning
▲ INDEX	Proper fit range
▶ RANGE	
ARTERY ▼	Artery position mark
LATEX FREE	No natural rubber
THIS SIDE TO PATIENT	Instructions to the patient
REF	Catalog number
LOT	Lot number
ADULT	Cuff size 22 cm to 32 cm
LL	Cuff size 41 cm to 50 cm
LARGE ADULT	Cuff size 31 cm to 45 cm
SMALL ADULT	Cuff size 16 cm to 24 cm
SS	Cuff size 12 cm to 17 cm
⚠	Means the symbol for suggestions on operation
CE	Means the symbol for showing the conformability mark

7. Measurements

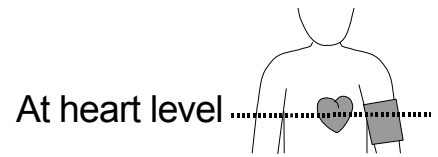

1. Place the cuff on the arm (preferably the left arm).
Keep the patient still during measurement.

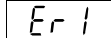

2. Press the  button.

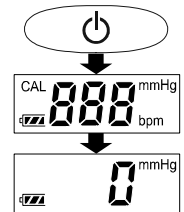
- When the  button is pressed, all of the display symbols will appear for about one second.
- When  starts flashing, the device is ready for measurement. If air is remaining in the cuff when the  button is pressed, the display will indicate an error code .



Turn the device off (press the  button again) and turn the exhaust valve counterclockwise once to release all the air in the cuff. Then press the  button again to reactivate the device.

3. Place the stethoscope on the brachial artery and pressurize the cuff by squeezing the rubber bulb. (Make sure the exhaust valve is completely closed.)
 - While the cuff is inflating, the pressure bar will move and in turn the LCD will display a number indicating the pressure.
 - Inflate the cuff to 30 to 40 mmHg higher than the patient's expected systolic value.

Note: If you wish to stop inflation at any time, press either the  button or turn the screw of the exhaust valve to release the air.

4. When inflation is complete.
 - Turn the exhaust valve screw to release air slowly.
 - Measure the systolic pressure and the diastolic pressure by stethoscopy.
5. The pulse rate is shown on the numerical display when the measurement is complete, and meets the following conditions.
 - When you pressurize 80mmHg or higher for the measurement.
 - When the pressure drops to 20mmHg or lower.

6. Turn the exhaust valve screw counterclockwise to release all the air from the cuff.

- ❑ If a measurement is taken with insufficient pressure, the `---` mark will be displayed. Re-pressurize the cuff to a pressure that is about 30 to 40 mmHg higher than the previous attempt.
- ❑ An error message `Err` will be displayed if a measurement is taken with insufficient pulses or in a very noisy environment.

7. Press the  button again to turn off the power.

Note: Model UM-102 has an automatic power-off function.

Allow at least three minutes between measurements on the same person.

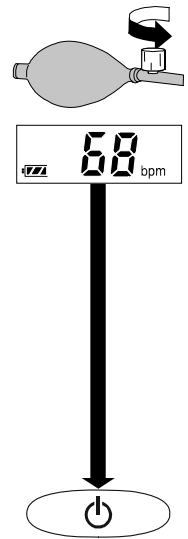

8. Useful Features

Measurement with MARK Button

You can put a marker at a certain pressure value when the `MARK` button is pressed during the measurement process. Up to 5 markings can be shown over the range of 40mmHg.

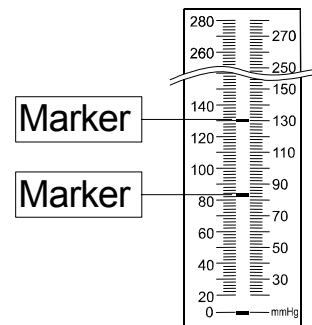

Lifetime Counter

When the `MARK` button is pressed while the device is off, the lifetime counter is displayed. This counter function indicates the hours the device was in use and helps to determine when maintenance is necessary. High digits and Low digits are alternatively displayed. The example indicates that the device has been in use for 1,278 hours.

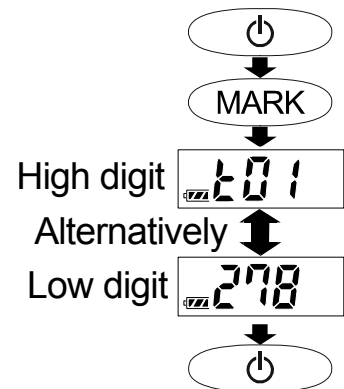

9. Troubleshooting

Problem	Possible Reason	Recommended Action
Nothing appears in the display, even when the power is turned on.	Batteries are empty.	Replace all batteries with new ones.
	Battery polarities are not in the correct position.	Reinstall the batteries with the negative and positive ends matching those indicated in the battery compartment.
The cuff is not inflated.	The cuff is not connected properly.	Check the twist of the air hose, and connection of the cuff and air hose.
	There is leakage of air from the cuff or rubber bulb.	Replace the cuff or rubber bulb with a new one.
Remain a display of  .	Error symbol is displayed one minute later.	Refer to "5. Symbols".

Note: If the recommendations above do not solve the problem, contact your nearest authorized A&D dealer. Do not attempt to open or repair this product by yourself, as any attempt to do so will render your warranty invalid.

10. Maintenance

Do not attempt to open the device as the delicate electrical components and intricate air unit inside could be damaged. If you cannot solve the problem using our troubleshooting guide, request assistance from your authorized dealer or from any A&D service group.

The device was designed and manufactured for a long service life. However it is generally recommended to have the device inspected every 2 years, to ensure proper functioning and accuracy. Please contact either your authorized dealer or A&D for maintenance.

CAUTION

- ❑ The sphygmomanometer is not waterproof device. Do not splash water on it and avoid exposure to moisture.
- ❑ Do not use a organic solvent such as thinner or benzine.
- ❑ The sphygmomanometer can not be sterilized by autoclave, EOG or formaldehyde etc.

Cleaning

- When cleaning the device and cuff, turn off the power by pressing  button and remove the batteries.
- When the main body or cuff is dirty, wipe them fully by using a gauze or cloth dampened with water or warm water avoiding excess water.
- To prevent a risk due to infection, disinfect the main body and cuff regularly. When disinfecting them, wipe them gently by using the gauze or dampened cloth with local antiseptic solution then wipe the moisture off the surface by using a dry soft cloth.
- Use the following medicine to disinfect the main body and cuff.

Ethanol (70%)
Isopropanol (70%)
Chlorhexidine Gluconate Solution (0.5%)
Benzalkonium Chloride Solution (0.05%)
Sodium Hypochlorite (0.05%)

11. Technical Data

Model	UM-102
Measurement method	Stethoscopy with stethoscope
Measurement range	
Numerical display	Pressure: 0 - 300 mmHg Pulse: 40 - 180 beats / minute
Pressure bar display	Pressure: 20 - 280 mmHg
Measurement accuracy	
Numerical display	Pressure: ± 3 mmHg Pulse: ± 5 %
Power supply	2 x 1.5 V alkaline batteries (LR6 or AA)
Upper arm circumference	22 - 32 cm using the adult cuff
Number of measurements	Approx. 2000 measurements, when AA alkaline batteries are used, with pressure value of 180 mmHg at room temperature of 23°C
Classification	Internally powered ME equipment Continuous operation mode
EMC	IEC 60601-1-2: 2007
Operating conditions	+10°C to +40°C / 15%RH to 85 %RH 800 hPa to 1060 hPa
Transport / Storage conditions	-20°C to +60°C / 10%RH to 95 %RH 700 hPa to 1060 hPa

Dimensions
 Weight
 Applied part
 Useful life

Approx. 98 [W] x 326 [H] x 202[D] mm
 Approx. 540 g, excluding batteries
 Cuff Type BF 
 Device: 5 years (when used six times a day)
 Cuff: 2 years (when used six times a day)
 Rubber bulb unit: 2years (when used six times a day)

Accessories sold separately

Cuff

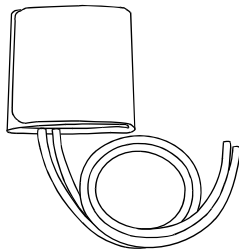

Catalog Number	Cuff Size	Arm Size
CUF-KW-LL	LL cuff	41 cm to 50 cm
CUF-KW-LA	Large adult cuff	31 cm to 45 cm
CUF-KW-A	Adult cuff	22 cm to 32 cm
CUF-KW-SA	Small adult cuff	16 cm to 24 cm
CUF-KW-SS	SS cuff	12 cm to 17 cm

Rubber bulb unit

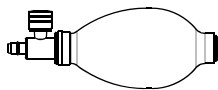

Catalog Number
UM-102-10

Connector and Plugs for cuff replacement

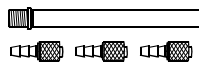

Catalog Number
UM-102-11

Mobile stand

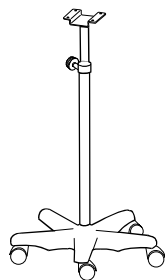

Catalog Number
UM-ST001

Note: Specifications are subject to change without prior notice.

Medical Electrical Equipment needs special precautions regarding EMC and needs to be installed and put into service according to the EMC information provided in the following. Portable and mobile RF communication equipment (e.g. cell phones) can affect Medical Electrical Equipment.

The use of accessories and cables other than those specified may result in increased emissions or decreased immunity of the unit.

Guidance and manufacturer's declaration – electromagnetic emissions		
The A&D unit is intended for use in the electromagnetic environment specified below. The customer or the user of the A&D unit should assure that it is used in such an environment.		
Emissions test	Compliance	Electromagnetic environment – guidance
RF emissions CISPR 11	Group 1	The A&D unit uses RF energy only for its internal function. Therefore, its RF emissions are very low and are not likely to cause any interference in nearby electronic equipment.
RF emissions CISPR 11	Class B	The A&D unit is suitable for use in all establishments, including domestic establishments and those directly connected to the public low-voltage power supply network that supplies buildings used for domestic purposes.
Harmonic emissions IEC 61000-3-2	n.a.	
Voltage fluctuations/flicker emissions IEC 61000-3-3		

Recommended separation distances between portable and mobile RF communications equipment and the A&D unit			
The A&D unit is intended for use in an electromagnetic environment in which radiated RF disturbances are controlled. The customer or the user of the A&D unit can help prevent electromagnetic interference by maintaining a minimum distance between portable and mobile RF communications equipment (transmitters) and the A&D unit as recommended below, according to the maximum output power of the communications equipment.			
Rated maximum output power of transmitter W	Separation distance according to frequency of transmitter m		
	150 kHz to 80 MHz $d = 1.2\sqrt{P}$	80 MHz to 800 MHz $d = 1.2\sqrt{P}$	800 MHz to 2.5 GHz $d = 2.3\sqrt{P}$
0.01	0.12	0.12	0.23
0.1	0.38	0.38	0.73
1	1.2	1.2	2.3
10	3.8	3.8	7.3
100	12	12	23
For transmitters rated at a maximum output power not listed above, the recommended separation distance d in metres (m) can be estimated using the equation applicable to the frequency of the transmitter, where p is the maximum output power rating of the transmitter in watts (W) according to the transmitter manufacturer.			
NOTE 1 At 80 MHz and 800 MHz, the separation distance for the higher frequency range applies.			
NOTE 2 These guidelines may not apply in all situations. Electromagnetic propagation is affected by absorption and reflection from structures, objects and people.			

Guidance and manufacturer's declaration – electromagnetic immunity

The A&D unit is intended for use in the electromagnetic environment specified below. The customer or the user of the A&D unit should assure that it is used in such an environment.

Immunity test	IEC 60601 test level	Compliance level	Electromagnetic environment – guidance
<p>Conducted RF IEC 61000-4-6</p> <p>Radiated RF IEC 61000-4-3</p>	<p>3 V_{rms} 150 kHz to 80 MHz</p> <p>3 V/m 80 MHz to 2,5 GHz</p>	<p>3 V_{rms}</p> <p>3 V/m</p>	<p>Portable and mobile RF communications equipment should be used no closer to any part of the A&D unit, including cables, than the recommended separation distance calculated from the equation applicable to the frequency of the transmitter.</p> <p>Recommended separation distance:</p> $d = 1.2 \sqrt{P}$ $d = 1.2 \sqrt{P} \quad 80 \text{ MHz to } 800 \text{ MHz}$ $d = 2.3 \sqrt{P} \quad 800 \text{ MHz to } 2,5 \text{ GHz}$ <p>where P is the maximum output power rating of the transmitter in watts (W) according to the transmitter manufacturer and d is the recommended separation distance in metres (m).</p> <p>Field strengths from fixed RF transmitters, as determined by an electromagnetic site survey,^a should be less than the compliance level in each frequency range.^b</p> <p>Interference may occur in the vicinity of equipment marked with the following symbol: </p>

NOTE 1 At 80 MHz and 800 MHz, the higher frequency range applies.

NOTE 2 These guidelines may not apply in all situations. Electromagnetic propagation is affected by absorption and reflection from structures, objects and people.

^a Field strengths from fixed transmitters, such as base stations for radio (cellular/cordless) telephones and land mobile radios, amateur radio, AM and FM radio broadcast and TV broadcast cannot be predicted theoretically with accuracy. To assess the electromagnetic environment due to fixed RF transmitters, an electromagnetic site survey should be considered. If the measured field strength in the location in which the A&D unit is used exceeds the applicable RF compliance level above, the A&D unit should be observed to verify normal operation. If abnormal performance is observed, additional measures may be necessary, such as re-orienting or relocating the A&D unit.

^b Over the frequency range 150 kHz to 80 MHz, field strengths should be less than 3 V/m.

Guidance and manufacturer's declaration – electromagnetic immunity

The A&D unit is intended for use in the electromagnetic environment specified below. The customer or the user of the A&D unit should assure that it is used in such an environment.

Immunity test	IEC 60601 test level	Compliance level	Electromagnetic environment – guidance
Electrostatic discharge (ESD) IEC 61000-4-2	± 6 kV contact ± 8 kV air	± 6 kV contact ± 8 kV air	Floors should be wood, concrete or ceramic tile. If floors are covered with synthetic material, the relative humidity should be at least 30%.
Electrical fast transient/burst IEC 61000-4-4	± 2 kV for power supply lines ± 1 kV for input/output lines	n.a.	Mains power quality should be that of a typical commercial or hospital environment.
Surge IEC 61000-4-5	± 1 kV differential mode ±2 kV common mode	n.a.	Mains power quality should be that of a typical commercial or hospital environment.
Voltage dips, short interruptions and voltage variations on power supply input lines IEC 61000-4-11	< 5% U_T (> 95% dip in U_T) for 0.5 cycle 40% U_T (60% dip in U_T) for 5 cycles 70% U_T (30% dip in U_T) for 25 cycles < 5% U_T (> 95% dip in U_T) for 5 s	n.a.	Mains power quality should be that of a typical commercial or hospital environment. If the user of the A&D unit requires continued operation during power mains interruptions, it is recommended that the A&D unit be powered from an uninterruptible power supply or a battery.
Power frequency (50/60 Hz) magnetic field IEC 61000-4-8	3 A/m	3 A/m	Power frequency magnetic fields should be at levels characteristic of a typical location in a typical commercial or hospital environment.

NOTE : U_T is the AC mains voltage prior to application of the test level.

AND

 **A&D Company, Limited**

1-243 Asahi, Kitamoto-shi, Saitama 364-8585 JAPAN
Telephone: [81] (48) 593-1111 Fax: [81] (48) 593-1119

EC REP

A&D INSTRUMENTS LIMITED

Unit 24/26 Blacklands Way, Abingdon Business Park, Abingdon, Oxfordshire
OX14 1DY United Kingdom
Telephone: [44] (1235) 550420 Fax: [44] (1235) 550485

A&D ENGINEERING, INC.

1756 Automation Parkway, San Jose, California 95131 U.S.A.
Telephone: [1] (408) 263-5333 Fax: [1] (408) 263-0119

A&D AUSTRALASIA PTY LTD

32 Dew Street, Thebarton, South Australia 5031 AUSTRALIA
Telephone: [61] (8) 8301-8100 Fax: [61] (8) 8352-7409