



GIMA

PROFESSIONAL MEDICAL PRODUCTS

SET DIAGNOSTICO F.O. XENON VISIO 2000 - 3,5V **VISIO 2000 F.O.XENON DIAGNOSTIC SET - 3.5V** **SET DIAGNOSTIC F.O. XÉNON VISIO 2000 - 3,5V** **SET DIAGNÓSTICO F.O. XENON VISIO 2000 - 3,5V**

È necessario segnalare qualsiasi incidente grave verificatosi in relazione al dispositivo medico da noi fornito al fabbricante e all'autorità competente dello Stato membro in cui si ha sede.

All serious accidents concerning the medical device supplied by us must be reported to the manufacturer and competent authority of the member state where your registered office is located.

Il est nécessaire de signaler tout accident grave survenu et lié au dispositif médical que nous avons livré au fabricant et à l'autorité compétente de l'état membre où on a le siège social.

Es necesario informar al fabricante y a la autoridad competente del Estado miembro en el que se encuentra la sede sobre cualquier incidente grave que haya ocurrido en relación con el producto sanitario que le hemos suministrado.

REF 31539



Gima S.p.A.
Via Marconi, 1 - 20060 Gessate (MI) Italy
gima@gimaitaly.com - export@gimaitaly.com
www.gimaitaly.com
Made in Pakistan



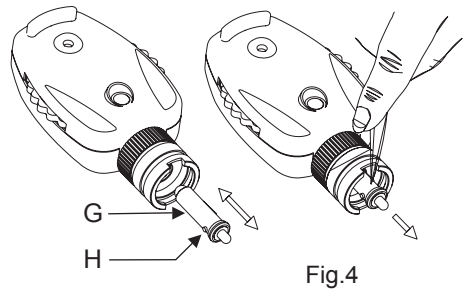
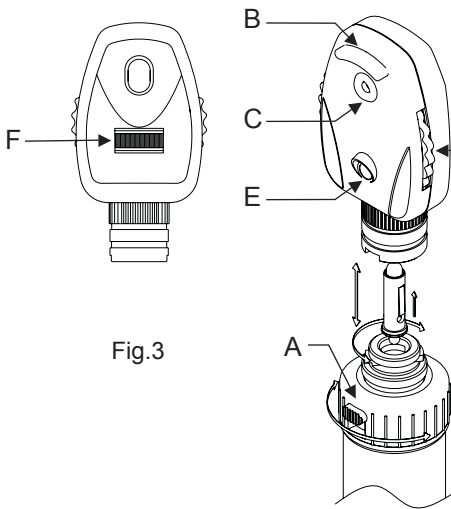
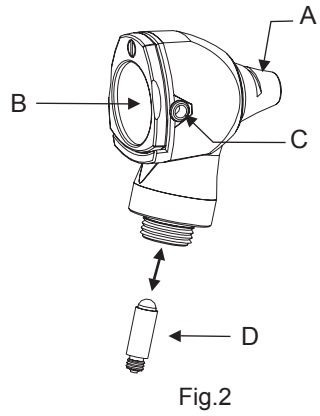
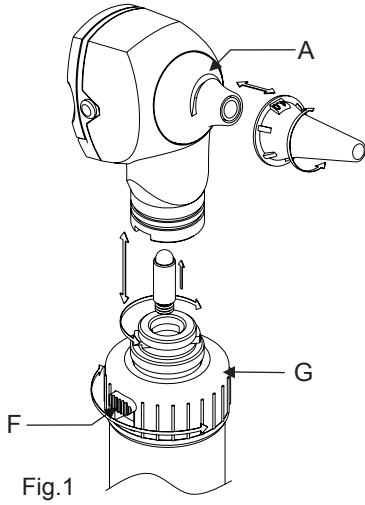

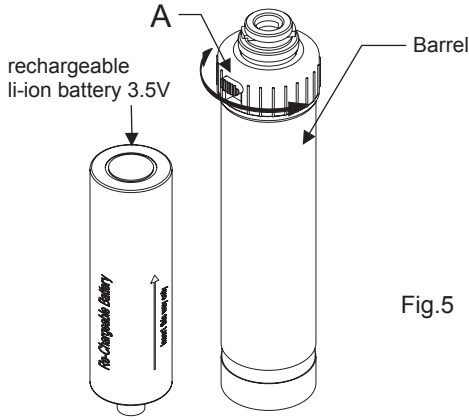

Fig.5

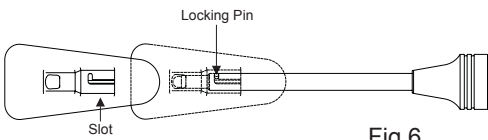
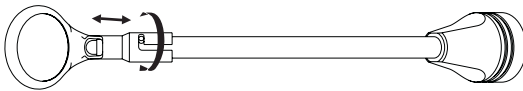
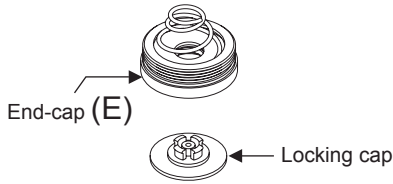

Fig.6

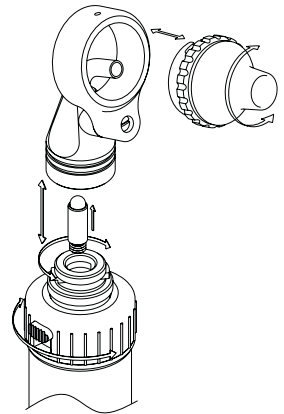
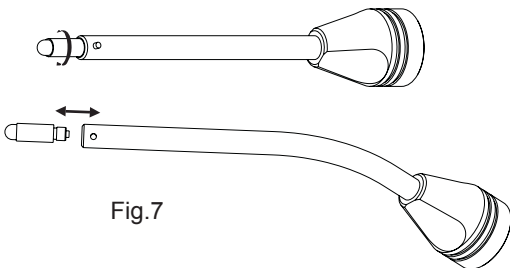
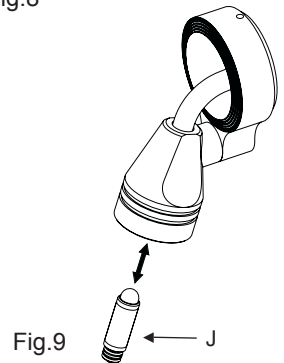

Fig.8



OTOSCOPE

The Otoscope is designed to examine the external ear and for general non-invasive examination.

Features:

- Made from Impact Resistant re-enforced plastic and highly reliable corrosion resistant stainless steel.
- Easy replacement of lamp.
- Distal fibre optic illumination with super bright 3.5V Xenon/Halogen.
- Insufflation port pneumatic testing of tympanic mobility.
- Swivel type window with 3x Magnification lense for sharp images and minimal Reflection.



The Otoscope should only be used to examine the ear when a tip is fitted. Pressure should be applied with great care when doing pneumatic testing.

OPERATING INSTRUCTION

Attach the otoscope head to the handle by bayonet locking system, it is necessary to hold the battery handle and head in each hand and match the bayonet grooves on both the head and handle, push the head down and turn the head clock wise as in Fig.1.

1. Check that the connection between the head and handle is perfect and that the rheostat works properly.
2. Push the button (F) on the handle and twist the black knob (G) towards the left hand side.
The unit is now in operating position. The intensity of the light can be adjusted by turning the knob clock wise or counter clock wise.
3. Switch off the unit after use to preserve batteries. Twist the black knob towards right until an audible click sound is heard once the button comes to its off position.

Attaching a tip

The Otoscope may only be inserted into the auditory canal when a disposable (grey) or reusable (black) tip is fitted. Push the tip onto the instrument so that the internal projection engages in the slit (A) as in Fig.1. Twist to the right to lock. Do not reuse the disposable speculum, because may cause patient-to-patient contamination.

Changing the lamp

With the Otoscope, first unlock the head from the handle and pull the lamp (D) downwards as in Fig.2. Push in the new lamp.

Magnifying lens

The lens (B) has 3 x magnifications and can be swiveled aside for instrumentation.

Insufflations port

An insufflations bulb can be fitted to the port (C). A separately Insufflations bulb is used for pneumatic testing of tympanic mobility.

General illumination:

The Otoscope can be used with or without a tip for general illumination of e.g. the oral cavity or skin. Avoid contact with sensitive or damaged skin.

CLEANING AND STERILIZATION

Otoscope head

Clean the outside with a soft cloth, inside with a cotton wool bud, if necessary soaked in disinfectant or water.



Do not use rough cloth for cleaning the lens to avoid scratches.

Reusable Ear tips

These can be cleaned, disinfected or sterilized by any conventional method. Autoclaving is allowed. (121°C)

OPHTHALMOSCOPE

The Ophthalmoscope is designed for all general ophthalmic examination.

Features:

- Made from Impact Resistant re-enforced plastic.
- Enhanced Xenon/Halogen super bright light.
- Easy replacement of lamp.
- Dust proof housing.
- 6 apertures to select from, micro spot, small spot, large spot, fixation, slit and red-free filter. This selection of apertures covers all the physician's needs in an ophthalmologic examination.



- Color coded 28 lenses for perfect examination (Green for +, Red for -)

0	1	2	3	4	5	6	7	8	9	10	12	15	20	40
	1	2	3	4	5	6	7	8	9	10	15	20	25	

OPERATING INSTRUCTION

Attach the ophthalmoscope head to the handle by bayonet locking system, it is necessary to hold the battery handle and head in each hand and match the bayonet grooves on both the head and handle, push the head down and turn the head clock wise as in Fig.3.

1. Check that the connection between the head and handle is perfect and that the rheostat works properly.
2. Push the button (A) on the handle and twist the black knob towards the left hand side. The unit is now in operating position. The intensity of the light can be adjusted by turning the knob clock wise or counter clock wise.
3. Gently place the rubber eye brow (B) near your eye. Viewing through window (C) point the light beam at the center of the eye lens.
4. With your index finger turn the wheel (D) clockwise or counterclockwise to select the desired lens. The power of the selected lens is visible through window (E).
5. The ophthalmoscope is equipped with a set of 6 different aperture, which can be selected by turning the wheel (F).
6. Switch off the unit after use to preserve batteries. Twist the black knob towards right until an audible click sound is heard once the button (A) comes to its off position.

Changing the lamp:

Unmount the ophthalmoscope head from the handle and pull the lamp (G) downwards as in Fig.4. Wipe the new lamp glass clean and insert it so that the locating pin (H) fits into the slit.

CLEANING

The housing can be wiped/clean with a cloth moistened with alcohol. Glass Surfaces can be cleaned with a cotton wool bud in the same way.

OPERATING THE HANDLE

Push button (A) in Fig.3 inward and rotate the knob clock wise which will turn the power on and the lamp will light up. This position is indicated by a RED indicator comes into view.

To switch off the instrument rotate the knob counter clock wise till an audible sound is heard.

Changing the batteries

Unscrew the end-cap (E) and shake out the old batteries.

Insert new batteries as Shown in Fig.5. Take care that the poles point in the right direction.

CLEANING

The handle can be cleaned with a cloth soaked with disinfectant however it cannot be dipped into liquids.

CURVED ILLUMINATOR

Various attachment such as mirrors and tongue depressors can be attached to the Illuminator. Align the slot on the distal end of illuminator and slide backward until it stops turn left to lock the pin as shown in Fig.6. To Remove reverse the above process.

Features

- Stainless Steel construction.
- Equipped with durable and easy locking system.
- To be used for Tongue Depressor & Plain mirror 20.0mm.
- Autoclavable and Disinfectable.

CLEANING AND STERILIZATION

The illuminators can be cleaned with a cloth moistened with Alcohol/IPA. These can be disinfected and sterilized by any conventional method. Autoclaving is allowed (121°C).

TONGUE DEPRESSOR & PLAIN MIRROR

Features:

- Made from resilient thermoplastic material.
- Smooth and shiny surface ensure easy cleaning.
- Easy Fixation on Illuminators.

CLEANING AND STERILIZATION

The illuminators, plain mirror and tongue depressor can be cleaned with a cloth moistened with Alcohol/IPA. These can be disinfected and sterilized by any conventional method. Autoclaving is allowed (121°C).

Changing of Lamp

For illuminator unscrew the lamp in counter clockwise direction until free. Replace the lamp and verify that lamp is sufficiently tightened before use as shown in Fig.7.

NASAL ILLUMINATOR

Attach the Nasal Illuminator head to the handle by bayonet locking system, it is necessary to hold the battery handle and nasal illuminator in each hand and match the bayonet grooves on both the nasal illuminator and handle, push the head down and turn the head clock wise as in Fig.8.

Features:

- Made from resilient thermoplastic material.
- Smooth and shiny surface ensure easy cleaning.
- Equipped with durable and easy locking system.
- Distal Fiber Optic illumination with super bright Xenon/Halogen Light.
- Easy replacement of lamp.

Changing the lamp:













With the Otoscope, first unlock the head from the handle and pull the lamp (J) downwards as in Fig.9. Push in the new lamp.

CLEANING AND STERILIZATION

The Nasal illuminator can be cleaned with a cloth moistened with Alcohol/IPA. This can be disinfected and sterilized by any conventional method. Autoclaving is allowed (121°C).

**Caution:**

- Do not use the equipment in case it is damaged. Apply to your Retailer.
- Periodically check the battery conditions, making sure that no sign of corrosion or oxidation is present. In case of necessity replace them with new ones.
- Carefully handle the batteries as the liquids can irritate skin and eyes.
- Before being used, thoroughly check the product. The same Operation shall be carried out after cleaning.
- Check that the connection between the head and the handle is perfect and that the On/Off Button works correctly.
- If the light is intermittent or in case it does not turn on, check the bulb, the batteries and the electrical contacts.

	Caution: read instructions (warnings) carefully		Follow instructions for use
	Keep in a cool, dry place		Keep away from sunlight
	Manufacturer		Date of manufacture
	Product code		Lot number
	Medical Device compliant with Regulation (EU) 2017/745		Type B applied part
	WEEE disposal		Medical Device



Disposal: *The product must not be disposed of along with other domestic waste. The users must dispose of this equipment by bringing it to a specific recycling point for electric and electronic equipment.*

GIMA WARRANTY TERMS

The Gima 12-month standard B2B warranty applies.