



GIMA

PROFESSIONAL MEDICAL PRODUCTS

OTO-OFTALMOSCOPIO F.O. SIGMA
SIGMA F.O. OTO-OPHTHALMOSCOPE
OTO-OPHTHALMOSCOPE À F.O. SIGMA
FASEROPTIK OTOSKOP-OPHTHALMOSKOP- SIGMA
OTO-OFTALMOSCOPIO F.O. SIGMA
OTO - OFTALMOSCÓPIO F.O. SIGMA
OTO-OFTALMOSKOP SIGMA F.O
SIGMA F.O. OTO-OFTALMOSCOP
ΩΤΟ-ΟΦΘΑΛΜΟΣΚΟΠΙΟ ΟΠΤΙΚΗΣ ΙΝΑΣ SIGMA
منظار فحص العين-الأذن كامل الخيارات من طراز **SIGMA** سيجما

È necessario segnalare qualsiasi incidente grave verificatosi in relazione al dispositivo medico da noi fornito al fabbricante e all'autorità competente dello Stato membro in cui si ha sede.

All serious accidents concerning the medical device supplied by us must be reported to the manufacturer and competent authority of the member state where your registered office is located.

Il est nécessaire de signaler tout accident grave survenu et lié au dispositif médical que nous avons livré au fabricant et à l'autorité compétente de l'état membre où on a le siège social.

Jeder schwere Unfall im Zusammenhang mit dem von uns gelieferten medizinischen Gerät muss unbedingt dem Hersteller und der zuständigen Behörde des Mitgliedsstaats, in dem das Gerät verwendet wird, gemeldet werden.

Es necesario informar al fabricante y a la autoridad competente del Estado miembro en el que se encuentra la sede sobre cualquier incidente grave que haya ocurrido en relación con el producto sanitario que le hemos suministrado.

É necessário notificar ao fabricante e às autoridades competentes do Estado-membro onde ele está sediado qualquer acidente grave verificado em relação ao dispositivo médico fornecido por nós.

Należy poinformować producenta i kompetentne władze danego Kraju członkowskiego o każdym poważnym wypadku związanym z wyrobem medycznym naszej produkcji.

Orice accident grav produs, privoritor la dispozitivul medical fabricat de firma noastră, trebuie semnalat producătorului și autorității competente în statul membru pe teritoriul căruia își are sediul utilizatorul.

Σε περίπτωση που διαπιστώσετε οποιοδήποτε σοβαρό περιστατικό σε σχέση με την ιατρική συσκευή που σας παρέχουμε θα πρέπει να το αναφέρετε στον κατασκευαστή και στην αρμόδια αρχή του κράτους μέλους στο οποίο βρίσκεστε.

يجب الإبلاغ فوراً عن أي حادث خطير وقع فيما يتعلق بالجهاز الطبي الذي زدونا به إلى الجهة الصانعة والسلطة المختصة في الدولة العضو التي يقع فيها

REF 31528 - 31533 - 31534 - 31584

 Gima S.p.A.
Via Marconi, 1 - 20060 Gessate (MI) Italy
gima@gimaitaly.com - export@gimaitaly.com
www.gimaitaly.com
Made in Pakistan



**OTOSCOPIO SIGMA - SIGMA OTOSCOPE - OTOSCOPE SIGMA
OTOSKOP SIGMA - OTOSCOPIO SIGMA - OTOSCÓPIO SIGMA
OTOSKOP SIGMA - SIGMA OTOSCOPI - ΩΤΟΣΚΟΠΙΟ SIGMA
SIGMA . منظار الأذن .**

Fig-2

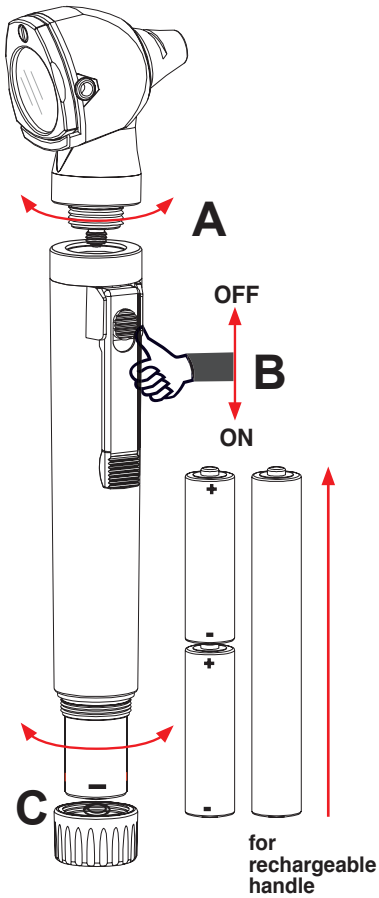

Fig-3

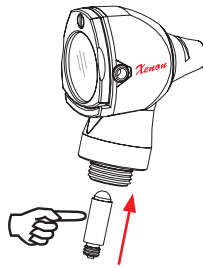

Fig-4

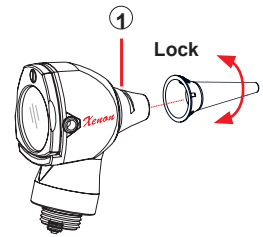

Fig-5

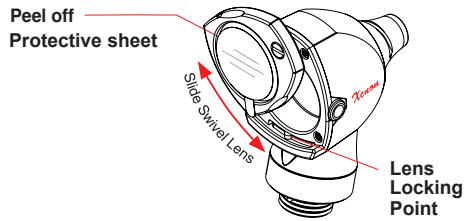

Fig-6

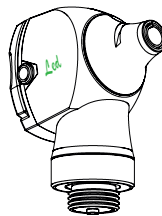
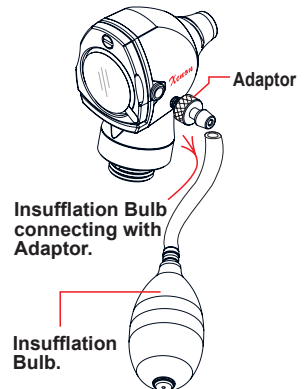

Fig-7



OFTALMOSCOPIO SIGMA - SIGMA OPHTALMOSCOPE
OPHTALMOSCOPE SIGMA - OPHTHALMOSKOP SIGMA
OFTALMOSCOPIO SIGMA - OFTALMOSCÓPIO SIGMA
OFTALMOSKOP SIGMA - SIGMA OFTALMOSCOPI
ΟΦΘΑΛΜΟΣΚΟΠΙΟ SIGMA - SIGMA منظار قاع العين

Fig. 8

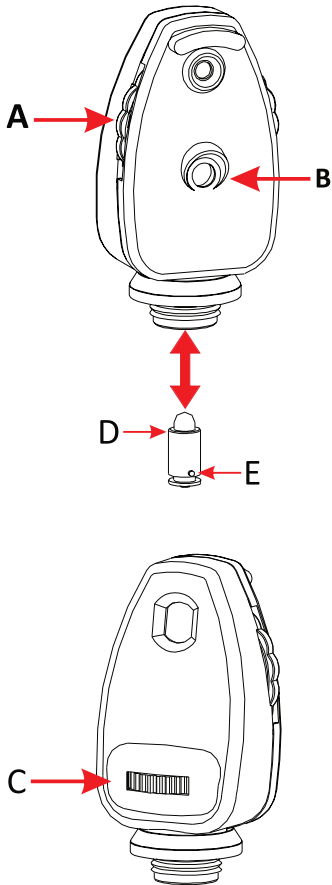
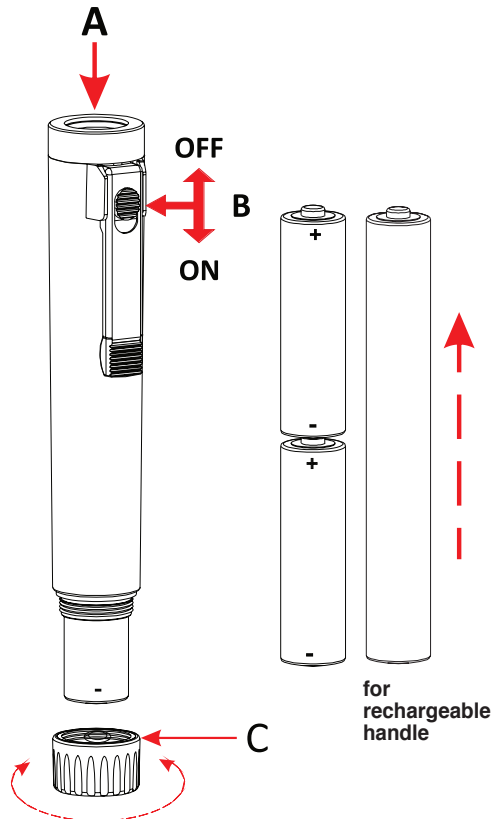

Fig. 9





- Do not use otoscope without ear tip that may cause ear injury and / or cross contamination.
- Do not reuse disposable ear tip that may result in contamination from one patient to another patient.
- Do not point light in patient eyes that may cause eye injury.
- Do not use excess force while locking the ear tip on head.

Magnifying Lens

Sigma Oscope has 3x magnification that produces distortion-free images of the examined object. The magnification viewing window is permanently attached and can be swivelled aside for instrumentation. To facilitate the instrumentation rotate the viewing window clockwise as much as required (Fig-5).



- Peel off the lens protective sheet before use (Fig-5).

Sigma LED otoscope model

The LED fixed and sealed into the otoscope head and cannot be changed because of its long life. LED has 50,000 hours of extended lifetime.

Ensure no replacement of LED ever in the lifetime of the instrument.

Excellent light output of 50K LUX.

Extended battery life of 50 HOURS due to low current consumption of LED.

With a colour temperature of 4000K and CRI>80 colours are visible as they are.

Ear Tip

Ear tip is used in otoscope as viewing passage for direct examination of the external acoustic duct and tympanic membrane.

Choose the size of Ear tip suitable for the examination of the acoustic duct.

Insufflation Port (optional)

Sigma Oscope have a connection port to facilitate the tympanic mobility test (Fig-7).

This can be carried out when the viewing window is closed by using optionally available insufflation bulb and adaptor.



- Dose the pressure carefully with the insufflation bulb.

Cleaning / Sterilization and Maintenance

The Sigma F.O. Pocket otoscope is not suitable for treatment in the ultrasonic bath, for sterilization, spray disinfection or treatment by immersion in liquids.

Manual Cleaning Process

Use a damp cloth for cleaning the Sigma pocket otoscope.

For cleaning and disinfection, a disinfectant agent suitable for plastic medical products must be used.

Handle Cleaning

The handle can be cleaned with a cloth soaked with disinfectant, however it cannot be dipped into liquids.

Do not use the equipment in case it is damaged. Apply to your retailer.

Periodically check the battery conditions, making sure that no sign of corrosion or oxidation is present. In case of necessity replace them with new alkaline ones.

Carefully handle the batteries as the liquids they contain can irritate skin and eyes.

Before being used, thoroughly check the product. The same operation shall be carried out after cleaning.

Check that the connection between the head and the handle is perfect and that the On/Off button works correctly.

If the light is intermittent or in case it does not turn on, Check the bulb, the batteries and the electrical contacts.



Precautions

Read the label before losing packing. Do not use if packaging has been open or damaged. Only qualified person should use it.

Handle the device with care and keep the instrument away from the range of insects and rodents.

Autoclaving is not permissible for this type of handle.

Ultrasonic cleaning is not recommended.

Store the device in clean environment at normal temperature.

Please ensure that the batteries, Handles and Ear Tips and other Sub-assemblies are discarded as clinical waste in accordance with local policies.

In accordance with local regulations this product should be disposed of as an electronic device separately.

SIGMA OPHTHALMOSCOPE

Range of applications

- The Sigma ophthalmoscope is designed for examination of the eye.
- During examination, hold the instrument with your index finger on the lens wheel (a) fig.8. you can also operate the aperture wheel (c) in this way.
- Window (b) shows the selected lens value. Minus lenses are shown red, plus lenses black.



Do not use the equipment in case it is damaged. Apply to your retailer.

Operating Instruction

Attach the ophthalmoscope head to the handle and turn on the device for examination, turn the wheel (a) fig.8, clockwise or counterclockwise to select the desired lens. The power of the selected lens is visible through window (b). Sigma ophthalmoscope is equipped with a set of 5 different aperture, which can be selected by turning the wheel (c).

Changing the lamp

Unscrew the instrument from the handle and pull the lamp (d) fig.8, downwards. Wipe the new lamp glass clean and insert it so that the locating pin (e) fits the slit.

Allow lamp to cool down for some time before replacing it.

Cleaning

The housing can be wiped clean with a cloth moistened with alcohol. Glass surfaces can be cleaned with a cotton wool bud in the same way.

Applicable Standards

ISO 15004-1 (Ophthalmic instruments - Fundamental requirements and test methods).



The performance of this instrument can only be guaranteed if genuine Medical Devices lamps and alkaline batteries are used.

Warnings and Cautions

The light emitted from the ophthalmoscope is potentially hazardous.

The longer the duration of exposure, the greater the risk of ocular damage. Exposure to light from this instrument, when operated at maximum intensity, will exceed the safety guideline after 13 minutes when lit with a LED lamp (blue base). Exposure times are cumulative for a 24-hour period.

- 333 seconds (5 min 33 sec) in case of a free eye
- 227 seconds (3 min 47sec) in case of a fixed eye



When using Halogen illumination, no acute optical radiation hazards are identified. However, Medical Devices recommends limiting the intensity of the light directed into the patient's eye to the minimum level that is necessary for diagnosis. Infants, persons with aphasia, and persons with diseased eyes are at a greater risk. The risk is also increased if the examined person has had any exposure with the same instrument or any other ophthalmic instrument using a visible light source within the previous 24 hours. This will apply particularly if the eye has had exposure to retinal photography. The intended use of this device is for routine ophthalmic exams on the order of typically less than 60 seconds per eye. Although there is a benefit versus risk factor in any medical procedure, these more complicated exams should not exceed a three minute exam time in 24 hours. Significant use of this device beyond its intended use is not recommended; it may cause harm to the eyes.

Feature

- Made from impact resistant re-enforced plastic.
- Enhanced Xenon/Halogen super bright light.
- Easy replacement of lamp.
- 5 different apertures.



- Large Spot: For normal fundoscopy.
- Small spot: For reduced reflection with small pupils.
- Semi Circle: For reduced reflection with small pupils.
- Fixation Star: For determination of central or eccentric fixation, very suitable for examining children.
- Red-free filter: For contrast-enhancement when assessing fine vascular disorders.
- Color Coded 18 lenses for excellent resolution (Black for +, Red for -).

+1	2	3	4	6	8	10	15	20
-1	2	3	4	6	8	10	15	20

Sigma Battery Handle

Range of applications

The sigma battery handle should only be used as a power source for Sigma instruments.

Instrument connector

Internal thread in handle head (a) fig.9.

Operating the Handle

Push switch (b) down which will turn the power on and the lamp will light up. This position is indicated by a RED indicator comes into view.

To switch off the instrument, push switch up.

Batteries

2 alkaline cells (AA/LR6).

Handle with rechargeable system

- The handle with rechargeable system has all the characteristics of a standard Sigma.
 - A metal cap (cod. 31588) converts standard handles into rechargeable ones.
 - The metal cap can be used both with "AA" batteries and the rechargeable battery.
- For grips with rechargeable system, a 2.5 V lithium-ion battery is used (code 31587), which is included in the set.

Note

The metal cap can be purchased separately, thereby converting a standard handle into a rechargeable one.

Changing the batteries

Unscrew the end-cap (c) and shake out the old batteries. Insert new batteries as shown in Fig. 9. Take care that the poles point in the right direction as indicated.

Cleaning

The handle can be cleaned with a cloth soaked with disinfectant; however it cannot be dipped into liquids.



- Do not use the equipment in case it is damaged. Apply to your retailer.
- Periodically check the battery conditions, making sure that no sign of corrosion or oxidation is present. In case of necessity replace them with new alkaline ones.
- Carefully handle the batteries as the liquids they contain can irritate skin and eyes.
- Before being used, thoroughly check the product. The same operation shall be carried out after cleaning.
- Check that the connection between the head and the handle is perfect and that the On/Off Button works correctly.
- If the light is intermittent or in case it does not turn on, check the bulb, the batteries and the electrical contacts.

TRANSPORT AND STORAGE

Before transporting the appliance, make sure that it is correctly packaged ensuring also that there are no risks of shocks bumps or falls during the transport itself.

Damage to the appliance caused during transport and handling is not covered by the guarantee.

The device must be stored in a dry, cool area away from direct sunlight.













It must not be placed in contact with any substances or chemical agents which could cause damage and reduce safety characteristics.

Operation

- Temperature 10°C - 35°C
- Humidity 30% - 75%
- Air pressure 700 hPa - 1060 hPa

Storage & Transport

- Temperature -20°C - 50°C
- Humidity 10% - 90% (without condensation)
- Air pressure 500 hPa - 1060 hPa

	Caution: read instructions (warnings) carefully		Follow instructions for use
	Keep in a cool, dry place		Keep away from sunlight
	Manufacturer		Date of manufacture
	Product code		Lot number
	Medical Device compliant with Regulation (EU) 2017/745		Type B applied part
	WEEE disposal		Medical Device



Disposal: The product must not be disposed of along with other domestic waste. The users must dispose of this equipment by bringing it to a specific recycling point for electric and electronic equipment.

GIMA WARRANTY TERMS

The Gima 12-month standard B2B warranty applies.