



# GIMA

PROFESSIONAL MEDICAL PRODUCTS

Gima S.p.A. - Via Marconi, 1 - 20060 Gessate (MI) Italy  
Italia: tel. 199 400 401 - fax 199 400 403  
Export: tel. +39 02 953854209/221/225 - fax +39 02 95380056  
gima@gimaitaly.com - export@gimaitaly.com  
[www.gimaitaly.com](http://www.gimaitaly.com)

## PLICOMETRO DIGITALE DIGITAL SKINFOLD CALIPER PLICOMÈTRE NUMÉRIQUE

### Manuale utente - User manual - Notice d'utilisation

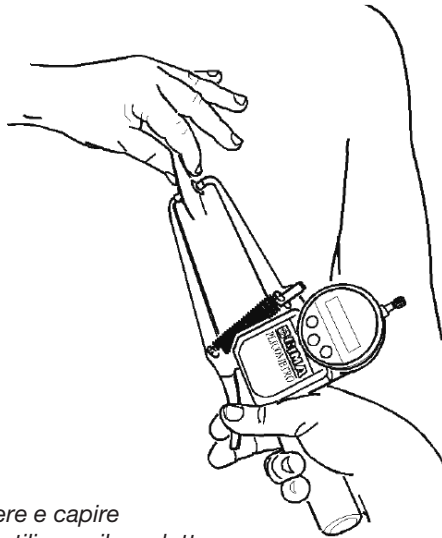

**ATTENZIONE:** Gli operatori devono leggere e capire completamente questo manuale prima di utilizzare il prodotto.

**ATTENTION:** The operators must carefully read and completely understand the present manual before using the product.

**AVIS:** Les opérateurs doivent lire et bien comprendre ce manuel avant d'utiliser le produit.

**REF** 27346



Metrica S.p.A.,  
Via Grandi n.18, 20097  
San Donato (MI) - Italy



0476



## ***PREMISE***

The purpose of the present manual is to offer the customer all possible information on the skinfold caliper as well as use and maintenance instructions allowing to preserve the skinfold caliper efficiency and performance over the time.

The user guide must be preserved in good conditions within reach for quick consultation.

The skinfold calliper is subject to updates and for this reason, components different from the ones showed in the pictures shall be installed; this possibility does not alter the explanations reported in the user guide and the skinfold caliper safety.

## ***INTENDED USE***

The skinfold caliper is addressed to medical staff's use and as such it has got the EC 0476 certification as medical device of class I with measuring function according to the EEC 93/42 directives.

## ***OBJECTIVE OF THE DEVICE***

A skinfold caliper is an instrument whose goal is to measure the thickness of a skin fold with its sublayer of fat in the body in mm or inches with a pressure of 10 gr/mm<sup>2</sup> ( $\pm 0\%$ ).

## ***USER INSTRUCTIONS***

- Turn the skinfold caliper on by pressing the mm/in button.
- Once it has been turned on, select the unit of measurement desired: "mm" for millimetres, "in" for inches using the button "mm/in"
- Before measuring, we recommend that you reset the zero value of the instrument: Press the button "ZERO" without applying any pressure to the arm of the clamp, making sure that the two PVC plates, located at the end of the arm, are in contact.
- Take the measurements according to indications provided in the following chapter.
- If the skinfold caliper is not used for approximately 5 minutes, the display will automatically turn off.
- If the display flashes or data is illegible, replace the battery: Rotating the plastic ferrule, once the battery area has been found replace the battery making sure that the polarities are observed.
- If the values on the display are blocked or the buttons do not work, try to reset the instrument by removing the battery (see above) and reinserting it after approximately 1 minutes.

## HOW SKIN FOLDS ARE ASSESSED

The skinfold caliper is applied to the skin fold after having moved the two sides of the folds with the sublayers of fat to be measured.

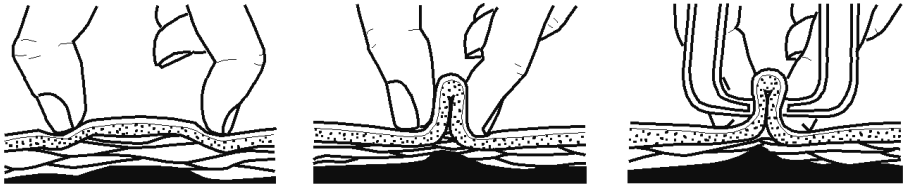

fig. 1

- 1 In order to assess the skin folds, firmly grasp a skin fold in between your fingertips of the thumb and index finger of the non dominating hand, and lift. In this way the skin and the underlying fat will be lifted and separated from the underlying muscular layers.
- 2 The arms of the skinfold caliper, after having extended them by using the relative grip, held using the contralateral hand, will be released transversally on the fold itself, immediately underneath (approximately 1 centimetre) the fingers that have lifted in, so as to measure the thickness. Reading of the values, in the selected scale, is performed directly on the instrument display and immediately after the skinfold caliper has been released so as not to provoke progressive and excessive squashing of the soft parts.
- 3 The value that shall be reported is equal to the arithmetical mean of two subsequent measurements in case the deviation between the two is not superior to 5%. In case the deviation is higher it is necessary to carry out a third measurement and calculate the average value between this last one and the previous measurements. In case of doubt, it is allowed to perform a higher number of counterchecks.  
Especially with women, some difficulties in lifting the skin folds can occur due to the fact that the subcutaneous tissue is often integral to the underlying muscular fascia, tightly adhering to it. In this case it is advisable to make the skinfold measurement be preceded by some pinching and releasing of the fold in sequence.

### SKIN FOLDS TO BE MEASURED:

- Tricipital and scapular in males (fig. 2)
- Tricipital and forethigh in females (fig. 3-4)

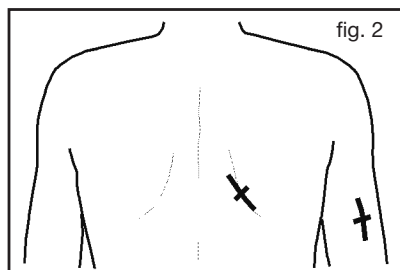

fig. 2

**Tricipital:**

Vertical fold measured along the medial tricipital line midway between olecranon (elbow) and corocoid apophysis (shoulder).

**Underscapular:**

Oblique fold (45°), extending from supero-medial to inferolateral, measured just under the scapula tip (shoulder). (fig. 2)

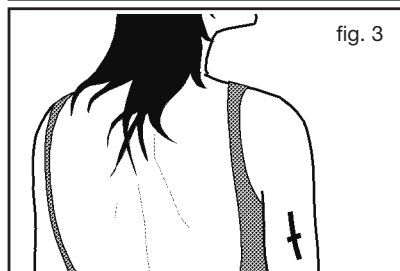

fig. 3

**Tricipital:**

Vertical fold measured along the medial tricipital line midway between olecranon (elbow) and corocoid apophysis (shoulder). (fig. 3)

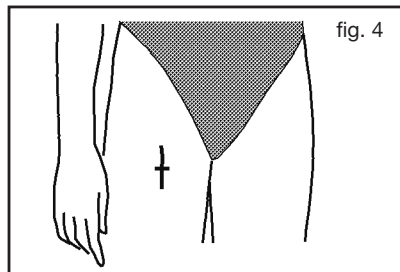

fig. 4

**Forethigh:**

Vertical fold on the thigh front medial line, midway between the kneecap and the upper edge of the iliac crest. (fig. 4)

**TABLES FOR THE ASSESSMENT OF FAT PERCENTAGES IN MALES**

- 1 Add up the thickness of TRICIPITAL and UNDERSCAPULAR folds after measuring them by means of the skinfold caliper.
- 2 Use the relative conversion table (see following page) in order to identify the corresponding values in the analogical scale.
- 3 Insert the figure indicated in the column related to age of the patient examined, stopping at the coinciding numerical level.
- 4 Scroll horizontally towards the right until the columns FAT and DIAGNOSIS in order to establish the values.

<b>AGE &lt;35 years</b>	<b>AGE 35-50 years</b>	<b>AGE &gt;50 years</b>	<b>FAT %</b>	<b>DIAGNOSIS OF ADIPOSITY</b>
8-12	7-11	6-10	4	very slim
13-18	12-17	11-16	8	slim
19-25	18-23	17-22	12	normal range
26-32	24-30	23-29	16	borderline adiposity
33-40	31-37	30-35	20	excessive adiposity
41-49	38-46	36-43	24	obesity
50-58	47-54	44-50	28	big obesity

### TABLES FOR THE ASSESSMENT OF FAT PERCENTAGES IN FEMALES

- 1 Add up the thickness of TRICIPITAL and FORETHIGH folds after measuring them by means of the skinfold caliper
- 2 Use the relative conversion table (see following page) in order to identify the corresponding values in the analogical scale.
- 3 Insert the figure indicated in the column related to age of the patient examined, stopping at the coinciding numerical level.
- 4 Scroll horizontally towards the right until the columns FAT and DIAGNOSIS in order to establish the values.

<b>AGE &lt;35 years</b>	<b>AGE 35-50 years</b>	<b>AGE &gt;50 years</b>	<b>FAT %</b>	<b>DIAGNOSIS OF ADIPOSITY</b>
17-24	16-22	15-20	13	very slim
25-33	23-31	21-29	17	slim
34-43	32-40	30-38	21	normal range
44-52	41-49	39-47	25	borderline adiposity
53-61	50-58	48-55	29	excessive adiposity
62-71	59-67	56-64	33	obesity
72-84	68-79	65-74	37	big obesity

**SCALE OF CONVERSION FROM ANALOGICAL TO DIGITAL**

<b>Analogical scale</b>	<b>MM digital</b>	<b>INCH digital</b>	<b>Analogical scale</b>	<b>MM digital</b>	<b>INCH digital</b>
0	0	0	21	2,73	.105
1	.12	.005	22	2,85	.110
2	.25	.010	23	2,99	.115
3	.38	.015	24	3,12	.120
4	.50	.020	25	3,24	.125
5	.64	.025	26	3,38	.130
6	.76	.030	27	3,49	.135
7	.89	.035	28	3,62	.140
8	1,02	.040	29	3,76	.145
9	1,16	.045	30	3,90	.150
10	1,29	.050	31	4,03	.155
11	1,41	.055	32	4,16	.160
12	1,54	.060	33	4,29	.165
13	1,66	.065	34	4,42	.170
14	1,80	.070	35	4,55	.175
15	1,93	.075	36	4,68	.180
16	2,06	.080	37	4,81	.185
17	2,18	.085	38	4,94	.190
18	2,32	.090	39	5,07	.195
19	2,44	.095	40	5,20	.200
20	2,58	.100			

***INSTRUCTIONS FOR INSTALLATION AND USE OF THE SOFTWARE (OPTIONAL)*****THE APPEARANCE AND EACH PART**

A USB connector for PC

B Data input

C Adapter

1 Connector for measuring tools

2 Status indicator

3 Data button (press to acquire data)

4 USB connector (For connection to personal computer)

- 5 Foot switch jack
- 6 Battery cover
- 7 Mute selector switch
- 8 Data acquisition mode selector switch
- 9 Measuring tool resolution selector switch
- 10 Standard transfer connector

## USE

- 1 Insert (4) to PC USB port, the PC system will identify the transmission device as “USB Composite Device” automatically in 10 seconds.
- 2 To acquire the data, insert connector (1) to measuring tools connector using the adapter (10) if necessary.
- 3 Move switch (9) to the select the desired resolution: 0.01mm / 0.001mm - 0.0005in / 0.00005in
- 4 Move switch (8) to select the data acquisition mode (see point 8)
- 5 **Open end user software:** any literal software which can be inputted on keyboard (such as Excel, Word, TXT and etc.) can work.
- 6 To operate the measuring tool, press button (3) one time, the measured data will be acquired to the above software where the cursor is. The cursor will do as follows:
  - A. **Enter:** once acquired the data, if ENTER is pressed the cursor skip to next line automatically, be equivalent to the computer Enter key;
  - B. **Tab:** once acquired the data, if TAB is pressed the cursor jump automatically to the left or down to the next text input form, be equivalent to the computer Tab key;
  - C. **Cursor:** once acquired the data, the cursor remains on that place, waiting for the operator manually move the cursor to the location where next measuring data have to be input. If the cursor is not moved new data will be entered always in the same cell.
- 7 Tone / Mute mode selection, As the draft, open (6), move (7) to tone mode or mute mode:
  - A. **Tone mode:** the status indicator (2) is on, when press DATA button and acquire the data successfully, the device has “beep” tone;
  - B. **Mute mode:** after connect with the PC, the status indicator (2) is off, when press DATA button and acquire the data successfully, the LED indicator flash once.

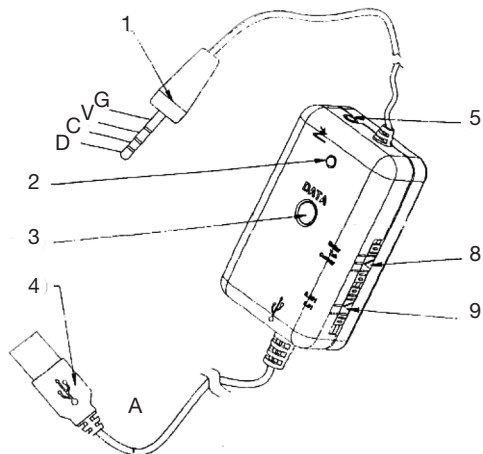

**Part A:**  
USB connector for PC

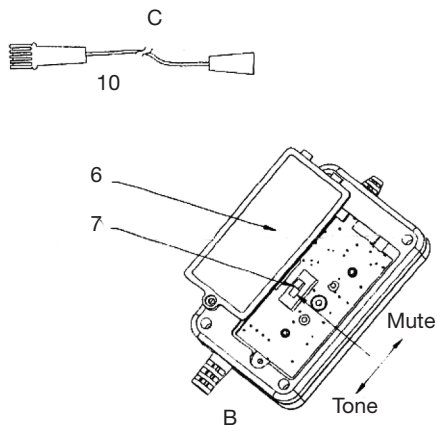

**Part B:**  
Data Input

8 Use the adapter (10) to let the Measuring tool compatible with the corresponding interface.

## TECHNICAL PARAMETER

**Work/storage environment**

0-40°C <75%  
-10-50°C, <95%

**Computer system**

Window 98 SE  
Window XP  
Window Vista  
Window 7

**Compter connection**

Standard USB port, wire long 2m

**Measuring tool connector**

4 cores plug (D / C / V / G)  
corresponding to:  
Data / Clock / Vcld / Get

**Wire long**

1.8 m

**Net Weight / Gross Weight**

100g/400g.





**Disposal:** *The product must not be disposed of along with other domestic waste. The users must dispose of this equipment by bringing it to a specific recycling point for electric and electronic equipment. For further information on recycling points contact the local authorities, the local recycling center or the shop where the product was purchased. If the equipment is not disposed of correctly, fines or penalties may be applied in accordance with the national legislation and regulations.*

### **GIMA WARRANTY CONDITIONS**









Congratulations for purchasing a GIMA product. This product meets high qualitative standards both as regards the material and the production. The warranty is valid for 12 months from the date of supply of GIMA. During the period of validity of the warranty, GIMA will repair and/or replace free of charge all the defected parts due to production reasons. Labor costs and personnel traveling expenses and packaging not included. All components subject to wear are not included in the warranty. The repair or replacement performed during the warranty period shall not extend the warranty. The warranty is void in the following cases: repairs performed by unauthorized personnel or with non-original spare parts, defects caused by negligence or incorrect use. GIMA cannot be held responsible for malfunctioning on electronic devices or software due to outside agents such as: voltage changes, electro-magnetic fields, radio interferences, etc. The warranty is void if the above regulations are not observed and if the serial code (if available) has been removed, cancelled or changed.

The defected products must be returned only to the dealer the product was purchased from. Products sent to GIMA will be rejected.





## Simboli - Symbols - Symboles

	<p>Conservare in luogo asciutto</p> <p>Keep in a cool, dry place</p> <p>À conserver dans un endroit frais et sec.</p>		<p>Conservare al riparo dalla luce solare</p> <p>Keep away from sunlight</p> <p>À conserver à l'abri de la lumière du soleil</p>		<p>Fabbricante</p> <p>Manufacturer</p> <p>Fabricant</p>		<p>Consultare il manuale d'uso</p> <p>Refer to instruction manual</p> <p>Lire attentivement la notice</p>
	<p>Prodotto conforme alla Direttiva Europea</p> <p>Product complies with European Directive</p> <p>Ce produit est conforme à la directive européenne</p>		<p>Codice prodotto</p> <p>Product code</p> <p>Code produit</p>		<p>Non smaltire con i rifiuti domestici</p> <p>Do not dispose with household waste</p> <p>Ne pas jeter avec les ordures ménagères</p>		<p>Attenzione: Leggere e seguire attentamente le istruzioni (avvertenze) per l'uso</p> <p>Caution: read instructions (warnings) carefully</p> <p>Attention: lisez attentivement les instructions (avertissements)</p>